



LIQUEFIED NATURAL GAS - The Driver of the Gas Era

by **Engr. Ahmad Rafidi bin Mohayiddin**, M.I.E.M., P. Eng.

INTRODUCTION

The world has seen a growing demand for gas as the fuel of choice, in addition to oil, coal, nuclear and other energy sources. When the global oil price rose exponentially in the past two years before crashing down to its current level, many oil producing countries became increasingly protective of their oil resources.

Other countries, whose economy depended extensively on oil as the primary energy, began to diversify their portfolios of sources. Gas, which is closely linked to oil, gained popularity during the time of the oil price rally. Although the price of natural gas is generally linked to the fluctuation in oil price, it is not influenced by global events as much.

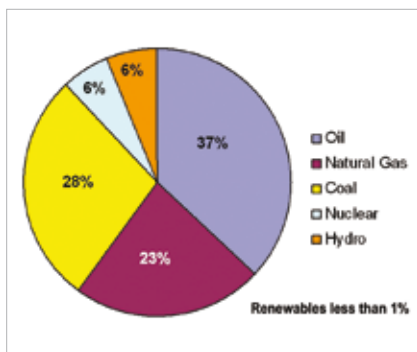

Figure 1: World energy mix pie chart [1]

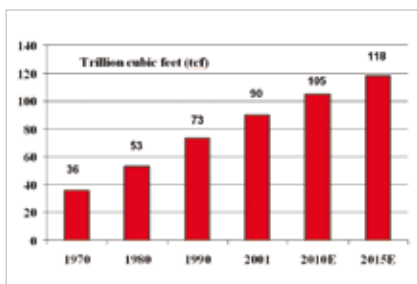

Figure 2: World gas demand from 1970 to 2015 [6]

In terms of the world's overall primary energy mix, gas ranks third at 23%, after oil (37%) and coal (28%). The remaining 12% balance is shared between nuclear, hydro and renewables [1]. Figure 1 shows this breakdown of the energy mix.

In terms of proven gas reserves, as of 1 January 2005, Russia and Iran top the list with about 1652 tcf (trillion cubic feet or 1×10^{12} ft³) and 953 tcf respectively out of the world total proven reserves of 6356 tcf [2]. Malaysia has proven gas reserves of 87 tcf and produces an average of 5 bcf (billion cubic feet or 1×10^9 ft³) per day [3][4]. This level of reserves ranks Malaysia at the 13th spot among countries in the world with gas reserves [5].

The demand for gas is increasing every year because it is considered a clean and efficient fuel, friendly to the environment and provides flexibility of use. Gas fuel emits fewer pollutants to the atmosphere compared to oil or coal. This demand has been on an upward trend from 73 tcf in 1990 to 90 tcf in 2001.

It is forecasted that by 2015, the world demand for gas will reach about 118 tcf per annum, representing about 27% of the energy mix [6]. Figure 2 shows the trend of gas demand from the year 1970 to 2015. It is, therefore, not surprising that many countries with a large amount of gas reserves have various strategies in place to ensure that they have full control of the exploitation and commercial arrangements of the gas supply in the world market.

In 2004, the largest producers of gas are Russia and the United States, representing about 98 tcf or 42% of

the world's output. Canada came in third at 6% of the total volume. The rest of the notable producers include the United Kingdom, Iran, Norway, Algeria, the Netherlands, Indonesia, Saudi Arabia, Malaysia, Turkmenistan and Uzbekistan [2]. China has also made headlines in recent years as one of the upcoming gas producing countries.

Most industrialised countries such as Japan and Korea, due to the unavailability or limited gas reserves of their own, are major users of gas in the Pacific region. The US, with its huge industries and large population is a major consumer in the Atlantic region. Emerging markets such as China and India look set to become giant consumers due to the exponential demand for gas to drive their booming economies. These two countries are tagged to become the next 'gas guzzlers' of the world.

NATURAL GAS

Natural gas is a naturally occurring hydrocarbon. Gas is normally found in pores and fractures of sedimentary rock deep beneath the earth's surface. The portion of the sedimentary rock layer that contains natural gas is referred to as a reservoir, field or pool [7]. There could also be what is termed 'associated gas' that exists together in oil reservoirs or 'non-associated gas' that occurs naturally. The oil and gas are believed to form from the degradation of organic materials buried in the earth millions of years ago.

Two mechanisms are believed to contribute to this gas formation. One is due to the action of bacteria (bacterial gas) on the debris accumulating in

FEATURE

SUPERINOX™ TUBES & PIPES

SUPERINOX manufactures high value-added welded stainless steel pipes of sizes 3/8" to 8", with an annual production capacity of 12,000 metric tonnes to meet the market demands.



The manufacturing process utilizes the latest advance Tri-Cathode welding technology incorporating with Japanese designed on-line heat annealing furnace and on-line Eddy Current defect detector



SUPERINOX has also been awarded the PED 97/23/EC Certificate by TÜV Nord, Germany and Product Certificate by SIRIM QAS, IKRAM QAS and all the Malaysian State Water-Works Authorities.



SUPERINOX PIPE INDUSTRY SDN. BHD. (712388-0)
1617, Lorong Perusahaan Maju 6,
Prai Industrial Estate IV,
13600 Prai, Penang, Malaysia.
Tel : +604-5021155 Fax : +604-5021100
E-mail : superinox@tattgiap.com.my
Website : www.superinoxpipes.com

the sediments, while the other occurs through the combined effects of temperature and pressure (thermal gas) [8].

Raw natural gas is composed primarily of methane (CH_4) and may also contain varying amount of ethane (C_2H_6), propane (C_3H_8), butane (C_4H_{10}), pentane (C_5H_{12}) and small percentage of C_{5+} hydrocarbons and some aromatics (BTX: benzene, toluene, xylenes). It may also contain non-energy components such as nitrogen (N_2), carbon dioxide (CO_2), hydrogen sulfide (H_2S) and water (H_2O). In some cases there is also a presence of mercury (Hg) in trace quantity and other contaminants. Figure 4 shows a representation diagram of the natural gas components.

The gas is drilled and extracted to the surface, preliminarily pre-treated and sent to gas processing facilities for further separation. Typical products of these gas processing plants are sales gas (methane), ethane, propane, butane and liquid condensates. The sales gas is normally used as energy fuel, albeit at a much reduced pressure, by the industry to generate electricity. Ethane is used in manufacturing. Propane and butane are normally mixed and sold as Liquefied Petroleum Gas (LPG), which is what we get in cooking gas cylinders. Butane is the gas found in cigarette lighters.

The main component that gives gas its value is the percentage of methane. This methane content varies from 80%-96% depending on the gas fields. Methane has a certain energy value and is measured in kJ (kilojoules). Another widely used unit of measurement is the imperial measure btu (British thermal units). One btu is equivalent to approximately to 1.055 kJ.

The more carbon atoms in a hydrocarbon gas, the higher its btu value. Methane contains one carbon atom per molecule as shown in Figure 5. Burning one cubic foot of methane gives off 1012 btu (1068 kJ). Butane possesses four carbon atoms and has a btu value more than three times larger than that of methane. Molecular hydrogen, on the other

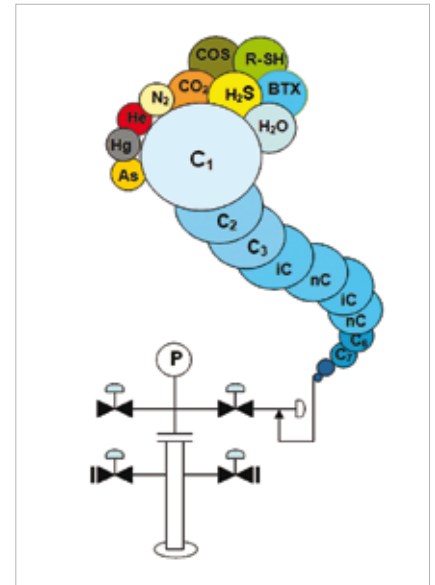

Figure 3: Natural gas components[8]

hand, although combustible, contains no carbon atoms and its btu value is three times smaller than that of methane.

GAS EXPLORATION AND TRANSPORTATION

The gas that is drilled and extracted from the fields is usually transported from its source to the treatment and processing facilities via pipelines. Upon processing, the gas sellers transport the processed gas to buyers also via pipelines. However, when the distance between the sellers and buyers becomes considerable and pipeline route becomes not commercially attractive, gas is normally transported by tankers or LNG carriers in the form of Liquefied Natural Gas (LNG). Figure 6 shows the basic gas chains that take place in between the gas source from the fields and before reaching consumers.

These two ways of processing and transporting, namely via pipelines or LNG carriers incur heavy and expensive infrastructures. That is the main reason gas sellers and buyers usually have made an upfront commitment before investing in the gas exploitation and processing activities. The sales and purchase agreement is usually sealed for a long-term deal, up to 20 years most of the times.

The international LNG trade via tankers has increased on average by

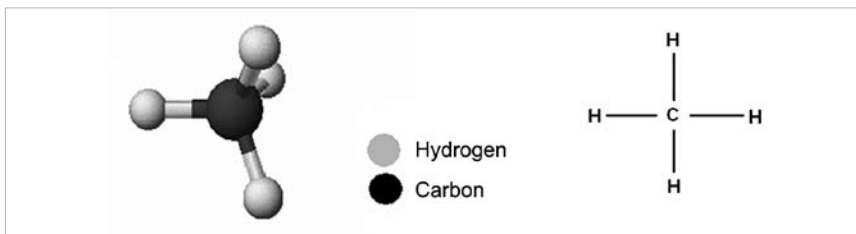

Figure 4: Model of methane (CH₄) molecule and structure

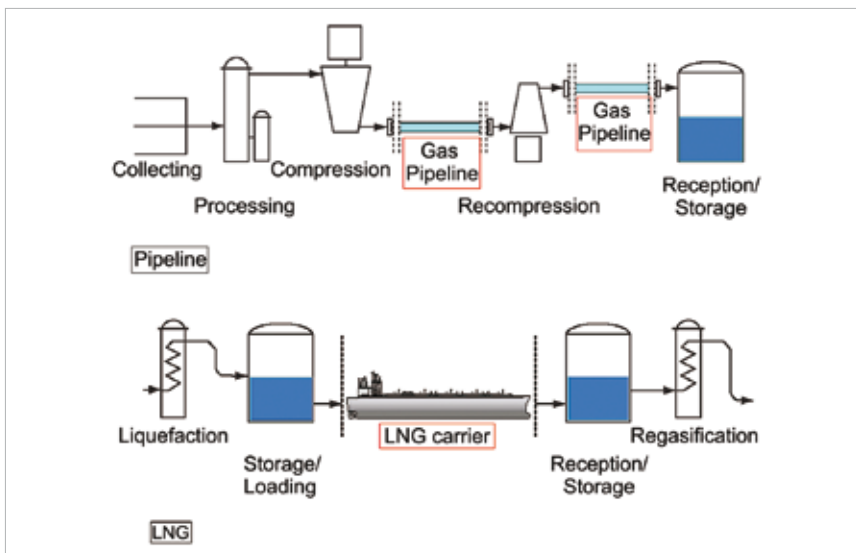

Figure 5: Pipeline or LNG[8]

Table 1: Useful conversion factors

| | 1 Billion cubic meters natural gas (bcm) | 1 Billion cubic feet natural gas (bcf) | 1 Million tons LNG (Mt) | 1 Trillion British thermal units (btu) |
|-------------------------|--|--|-------------------------|--|
| 1 Million tons LNG (Mt) | Multiply by 1.38 | Multiply by 48.7 | Multiply by 1 | Multiply by 52.0 |

7.2% per annum over the last ten to twelve years, reaching to about 6.6 tcf in 2005. Over this same period, international gas trade by pipeline has grown by only about 6% per annum [9]. The growth of this international LNG tanker trade has regularly outpaced that of international pipeline trade. Based on this powerful growth trend, LNG share of world gas trade could reach about 38% by 2020 to approximately 16.7 tcf or 343 Mt (Million tons) [9]. The term Million tons is frequently quoted in any discussion on LNG. Table 1 provides some useful conversion factors as reference.

LIQUEFIED NATURAL GAS (LNG)

Liquefied Natural Gas or LNG is natural gas in its liquid stage. This is

achieved by compressing the natural gas, methane primarily to a temperature of approximately negative 161°C at atmospheric pressure (100 kPaG). At this temperature, the gas takes up a volume of 1/600th (600 times smaller) of its gas state. At this considerably reduced volume, it is more practical to store and bulk transport the gas to users at further locations from the gas fields. The liquefied gas in the form of LNG will then be re-gasified at the buyers' location for use.

LNG is odourless, colourless, non-corrosive and non-toxic. It is a clear liquid with a density of about 45% of water density. However, as with other gaseous material, the vaporised gas from LNG can cause asphyxiation in an unventilated confinement [10].

EXECUTIVE DEVELOPMENT PROGRAMME

Executive Master in Occupational Safety & Health Management

(In collaboration with BATC - UTM)

2 DAYS WORKSHOP ON AIRPORT PLANNING & MANAGEMENT

11 & 12 MAY 2009
HILTON HOTEL, KUCHING

2 DAYS WORKSHOP ON RAILWAY ENGINEERING MANAGEMENT

3 & 4 AUGUST 2009
HOLIDAY VILLA, SUBANG

SEMINAR ON PROJECT MANAGEMENT

23 & 24 NOVEMBER 2009
SUTERA HARBOUR, KOTA KINABALU

Managed by :

Kindly Contact :

En. Fakri : 012-622 5415, 03-8783 1002
Cik Sha : 03-8783 5031 | Cik Nadwa : 012-6406 489

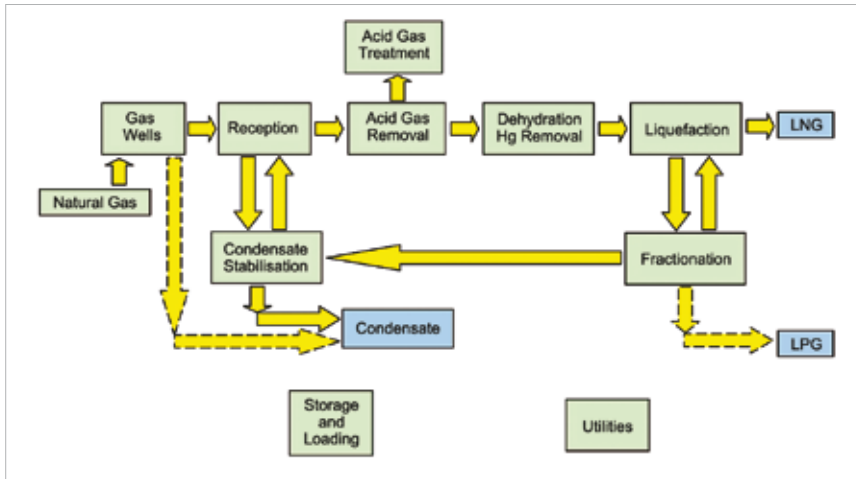

Figure 6: Basic LNG block flow diagram[10]

Table 2: Licensors used in LNG Plants[11]

| Liquefaction Process | Licensor | % of Market* |
|-------------------------------|-------------------|--------------|
| Propane Pre-cooled MR | APCI | 77 |
| Optimised Cascade | Conoco-Phillips | 9 |
| Single Refrigerant MR | APCI | 5 |
| Classic Cascade | Marathon/Phillips | 1 |
| Teal Dual Pressure MR | Unknown | 1 |
| Prico Single Stage MR | Back & Veath | 2 |
| MR Processes (C3MR & Dual MR) | Shell | 4 |
| Multifluid Cascade | Linde-Statoil | 1 |
| AP-X Process | APCI | 0 |

(*Note: % of market share based on percentage of total trains running and under construction.)

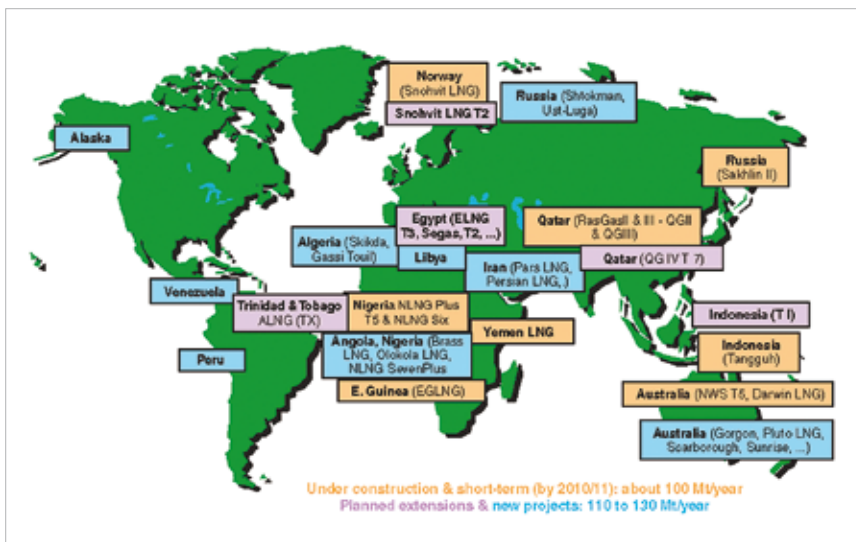

Figure 7: Liquefaction projects worldwide[9]

In general, the stages involved in producing LNG from natural gas coming in from the fields involve pre-treating, drying, separating, and cooling and liquefying processes.

Figure 7 shows the basic LNG block flow diagram.

Pre-treatment (Pre-treating) involves removing any impurities such as acid gases and sulphur compounds

that could interfere with processing or are not desirable in the final products. Dehydration (drying) involves removing water and impurities that could solidify at negative temperatures (below 0°C). Liquefaction (cooling and liquefying) involves separating the heavier hydrocarbons and leaving behind mainly the methane component in 'sweet' gas and then liquefying the methane gas into a 'cryogenic' liquid (LNG) at -161°C. Fractionation (separating) involves the recovery of heavier hydrocarbons such as ethane, propane and butane that separate during cooling to be utilised for other purposes described earlier.

LNG LIQUEFACTION TECHNOLOGY

The heart of any LNG plant is the liquefaction process. The majority of these processes are proprietary processes that have been developed and refined by the process licensors over the years. Owners of any LNG plants will have to evaluate and select the right process for their plant and pay the licensors for the process. Construction of a new baseload LNG plant is capital intensive and the liquefaction process technology is one of the key investment decision factors. The cost of the liquefaction process constitutes as much as 35% of the total cost of the plant.

There exist a number of licensed processes to cool and liquefy natural gas into LNG. The most common process found in the majority of LNG plants around the world is the APCI (Air Products and Chemicals Int.) 'Propane Pre-cooled MR' process. This involves the use of a mixed-type refrigerant as the medium to cool and extract the heat out from the gas. These refrigerants are normally propane and a mixture of butane. Other licensed processes used in the LNG plants and the percentage of market share that they command is given in Table 2. The different processes offer their own advantages against the others and the selection of one will usually be completed during the conceptual and feasibility studies for a new plant.

LNG PLANTS

In 2004, the LNG trade was approximately 131 Mtpa and is expected to increase to more than 190 Mtpa in 2010. As of October 2005, there were a total of 19 liquefaction facilities in operation worldwide with a combined production capacity of 150 Mtpa [11].

In 2006, available data showed that existing liquefaction facilities worldwide stood at 176 Mtpa. Some projects, which are currently under construction, will add about 110 Mtpa to this capacity by 2010/11 as shown in Figure 8 [9]. A number of the existing LNG plants in the world are also going through expansion or debottlenecking to increase their capacity. This suggests that many investors are banking on LNG to become a more significant feature in the world gas trade.

Malaysia has the world's largest LNG plants in a single location with a total capacity of 23 Mtpa. These are in the shape of the PETRONAS' MLNG, MLNG Dua and MLNG Tiga Plants in Bintulu, Sarawak [4].

A typical LNG plant normally has a capacity between 3 to 8 Mtpa per

train with plants having between one to eight trains. A train is one complete process unit from feed to end product so that each train is independent of the others. Shutdown of one train for maintenance, for instance, will not affect the others but will reduce the total plant production volume.

It is estimated that 1 tcf of gas reserves is usually required to produce an LNG plant of about 1 Mtpa capacity for 20 years. A decision to proceed with the construction of an LNG plant normally requires at least a production capacity of 3 Mtpa. This translates to having about 3 tcf of gas supply sources although some investors may proceed with much less based on their own economic studies.

CONCLUSION

Since the first natural gas production in 1821 in Fredonia in New York State, US [7], natural gas has come a long way to dominate the energy mix of the world. Its tremendous demand growth has been largely attributed to its environmentally friendly characteristics and its flexibility of use.

The earlier method of gas transportation via pipelines has seen

an alternative in transporting via LNG carriers. Although the first LNG plant was built in 1912, the commercial trade of LNG only gained momentum in the 1970s. The advancement in liquefaction technology and bulk LNG carriers has led to the access of more stranded gas reserves, which were not economical to be developed previously. This has allowed the supply and demand of the gas market to flourish both in the Pacific and Atlantic regions.

Technological advances are constantly being made to refine existing or new liquefaction technologies that could give the highest efficiency and lowest cost per million ton of LNG. More and more LNG plants are starting to take shape, especially in the Middle East, to cater to the increasing demand for gas. With the growth in the demand for gas, the world will surely see more of LNG dominating the onset of the gas era. It is not too farfetched, and based on the growth of the gas industry, analysts have even predicted that gas could even surpass coal and assume the second spot after oil as the fuel of choice. This will undoubtedly be in the form of LNG. ■

REFERENCES

- [1] Webber, Calliope. "Associated Gas Utilisation and Sustainability" GasTech 2006 Conference Proceedings, Abu Dhabi, Dec 2006.
- [2] Institut Francais Du Petrole (IFP). "Gas Reserves, Discoveries and Production" Panorama 2006 Seminar. http://www.ifp.com/information-publications/notes-de-sythese_panorama/panorama-2006/reserves-de-gaz-decouvertes-production, accessed on 2 Mar 08.
- [3] Von Der Mehden, Dr. Fred R. and Troner, Al. "PETRONAS: A National Oil Company With An International Vision", The James A. Baker III Institute for Public Policy, Rice University, 2007.
- [4] M. Razali, Razmahwata and Salim, M. Azlan. "The Economics of Natural Gas", JURUTERA, June 2007.
- [5] Malaysian Gas Association. "The Gas Industry in Malaysia" MGA Report <http://www.malaysiangas.com/index.php?module=GasIndustries>, accessed on 23 Apr 08.
- [6] Frank, Sergey O. "How the Technical Innovator Can Succeed in the Commercial World of LNG" GasTech 2006 Conference Proceedings, Abu Dhabi, Dec 2006.
- [7] Natural Resources Canada. "Natural Gas: A Primer" http://www2.nrcan.gc.ca/es/erb/CMFiles/Natural_Gas_Facts209JLL-06032006-3651.pdf, accessed on 4 Apr 08.
- [8] CEDIGAZ Papers and Articles "Natural Gas Fundamentals" Jul 2002, http://www.cedigaz.org/products_services/papers.aspx, accessed on 3 Apr 08.
- [9] Institut Francais Du Petrole (IFP). "LNG: A Commodity in the Making" Panorama 2006 Seminar. <http://www.ifp.com/information-publications/notes-de-synthese-panorama/panorama-2006/le-gnl-une-commodite-en-devenir>, accessed on 2 Mar 08.
- [10] Shukri, Dr. Tariq. "LNG Technology Selection" Hydrocarbon Engineering, Feb 2004.
- [11] Barclay, Michael and Denton, Noel. "Selecting Offshore LNG Processes", LNG Journal, Nov 2005.