

Adapting SICK PLS 101 Laser Scanner for 3D Interior Modelling Data Collection

Shazmin Aniza Abdul Shukor^{a*}, Emma Rushforth^b

^aSchool of Mechatronic Engineering, Universiti Malaysia Perlis, 02600 Perlis, Malaysia

^bWarwick Manufacturing Group, University of Warwick, Coventry CV4 7AL United Kingdom

*Corresponding author: shazmin@unimap.edu.my

Article history

Received :5 February 2014

Received in revised form :

7 April 2014

Accepted :20 May 2014

Graphical abstract



Abstract

This paper highlights on the process of optimizing a SICK PLS 101 laser scanner sensor to collect 3D data of building interiors. The sensor, which is an industrial-based, is used to perform tasks like inspection, metrology and safety. 3D modelling of building interiors has gained a lot of interest recently, and the model can be used as the 3D as-built and assist facility management processes, as well as for preserving and conservation of old important buildings. On the other hand, not all sensors are capable of generating suitable data that can be used to produce the 3D model. LIDAR for example, is the preferred sensor in collecting interior data, but is prohibitive to some due to its cost. In addition to that, it usually comes with its own programme to collect the data, which can lead towards standardization issues. Other system like stereo vision can also be used; however it has limitations when handling occlusion and clutter while capturing in-use interior data. Thus, utilizing a SICK PLS 101 laser scanner to collect 3D interior data will provide a low cost solution in producing 3D interior models. The laser sensor can only scan in 2D for 180° horizontal area, yet by installing a servo motor, it is able to scan a hemispherical area in one operation. The overall system is sufficient to gather 3D data of a building interior – it can handle occlusions and clutter within an interior, is able to produce a standard ASCII file as well as generating output with adequate resolution, which can also solve the issues of standardization and the massive datasets created by LIDAR. As a conclusion, by optimizing a SICK PLS 101 laser scanner, we are able to produce a low cost, low level solution to gather 3D data of building interiors. Due to the restriction in cost and features of other sensors, the capability to utilize this sensor is appreciated.

Keywords: Laser scanner; sensor technology; 3D interior model; 3D as-built; building information modelling

© 2014 Penerbit UTM Press. All rights reserved.

1.0 INTRODUCTION

3D modelling of building interiors has started to get attention since the late 1990s when Building Information Modeling (BIM) is being introduced. This model can be used to assist building owners, architects, engineers and managers to manage the interior as well as assisting renovation processes. Apart from this, 3D models are also being used for historical building preservation and for mobile robot navigation.

By having a 3D model, a lot of information about that particular interior can be accessed from it, hence, the data collection component is essential. In addition to that, gathering data representing an in-use building interior is a complicated process, due to the existence of clutter and occlusion, plus the complexity of the structure itself. Selecting a suitable sensor to collect the interior data is crucial, as an inappropriate device may lead to longer collection time. Apart from that, existing sensors come with a variety of specifications that need to be considered.

Early methods of collecting interior data for 3D modelling purposes were by fusing two or more sensors, as a single 2D sensor was not capable of generating 3D data due to its deficiency in obtaining depth information. Sensors like cameras and 2D laser scanners were being fused together to collect 3D data of an interior. However, this approach requires a lot of tedious work to handle clutter and occlusion issues, apart from the large computational task in generating the 3D model.

Due to the above, manufacturers are now developing 3D laser scanners (also known as LIDAR-Light Detection and Ranging or LADAR-LAsER Detection and Ranging) to enable professionals to collect building interior data in 3D. These scanners are now available commercially at different levels of specifications. Nevertheless, a state-of-the-art laser scanner is costly and prohibitive to many.

Therefore, to develop a low cost solution that is capable of collecting 3D data representing building interiors would be significant and important. The difference in cost is emphasized in Table 1. This paper will concentrate on the development of such a

solution by optimizing an industrial-based laser scanner. Improvements towards the laser scanner as well as its operations will also be included. Although it carries lower specifications

compared to other scanners (refer to Table 1), results will demonstrate that it is sufficient enough for this application.

Table 1 Comparison of 3D laser scanners

	Scan rate	Scan area (°)	Range (m)	Price (USD)
RIEGL LMS-Z210	8000 points / second	80 vertical, 360 horizontal	800	21,000
CYRAX	1000 points / second	40 vertical, 40 horizontal	100 (recommended maximum range 50)	45,000
Leica HDS3000	Thousands to millions points / second	270 – 310 vertical, 360 horizontal	79 – 300	35,000 – 55,000
Perceptron P5000	0.24 degree / second	60 vertical, 60 horizontal	40	Not available due to obsolescence
SICK PLS 101	1 degree / second	180	50	2,000

The rest of this paper will review the literature of similar work (Section 2.0), while Sections 3.0 and 4.0 discuss the methodology on the optimization of the sensor and the results and discussions, respectively. It then concludes in Section 5.0.

2.0 LITERATURE REVIEW

The most critical part in data collection is to handle occlusion and clutter due to furniture like tables and chairs as well as other equipment such as computers, bins and book shelves. Hence 3D laser scanners are preferred as they can handle clutter and occlusion while gathering the data. However these scanners are costly and researchers have come out with several low cost solutions to overcome this.

Early researchers have used 3D laser scanners for 3D building modelling reconstruction. In [1] and [2], Perceptron is used to collect data of indoor scene and synthetic objects with occlusions respectively, whereas [3] and [4] used a CYRAX laser scanner to solve urban environment modelling. Riegl laser scanner is being used by [5] for indoor scene data collection. However, this early work was more into modelling of partial or close-up views of interiors.

Leica laser scanners are used in [6] for reconstructing planar surfaces of a hallway. Meanwhile, recent research from Carnegie Mellon University obtained their 3D data from a professional surveyor who uses a state-of-the-art laser scanner [7] [8]. Due to the cost limitations, researchers have to depend on the professionals to supply the 3D interior data and thus, the number of data sets collected will be restricted. This situation will not allow the researchers to test their methods on a variety of interiors and reconstruct more 3D models.

To avoid the costing issue, some research fused different sensors to gather the 3D data. In [9], a system which consists of a camera and a range sensor is used, while [10] made use of information obtained from a dead-reckoning sensor which captures the location of the autonomous vehicle carrying a LIDAR. Nevertheless, sensor fusion system will carry a lot of computational tasks in processing the data to model them.

Another low cost solution is by using stereo vision. Stereo vision system was only being considered to collect interior data for modelling purposes in 2009, even if there were quite significant developments of mobile robotics using stereo vision in late 1990s. In [11], the authors claimed that the increased usage of stereo in indoor modelling perception in 2009-2010 was due to the pioneer work made by [12], which uses real-time stereo to develop 2D grid maps for mobile robot navigation. More work using stereo in 3D interior modelling can be found

in [13] and [14]. However, data from stereo cannot be used to reconstruct surfaces with occlusions without extra tedious work, which is essential in 3D interior modelling of in-use buildings.

3.0 METHODOLOGY

SICK proximity laser scanner (PLS) 101 is an industrial-based, time-of-flight sensor. It uses infrared laser beams to scan its surroundings. It emits very short light pulses which are reflected back when they hit a target. The distance, d , of the target from the scanner can be determined using the equation:

$$d = \frac{c \times t}{2}$$

where

c = speed of light

t = time the light pulse takes to travel to the target and return

There is a uniformly rotating mirror inside the scanner which is used to determine the direction of the target. Both the distance and direction will be used to determine the target's precise position in 3D (x , y , z -direction). Figure 1 show the laser scanner used in this research.



Figure 1 The SICK PLS 101 laser scanner [15]

Originally, the scanner moves in a 2D horizontal semicircular plane acquiring 1 point per degree, as shown in Figure 2. The user can select any scan angle up to maximum of 180° horizontally. Figure 3(a) shows the condition of the laser scanner used in this work, which is being rotated to allow maximum scanning area and mounted on a mobile platform with 45 cm height above floor to allow portability [16]. By installing a servo motor on the side of the laser scanner (refer to Figure 3(a)), it will allow the sensor to scan a hemispherical area in a

single operation, as shown in Figure 3(b), and this took about 3 minutes (1 degree / second). By having this arrangement, the laser scanner can generate 3D point cloud data. Table 2 highlights some of the scanner’s specifications.

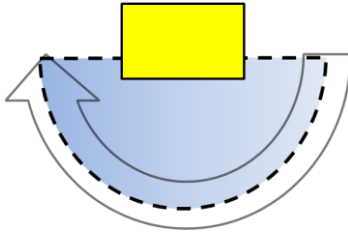
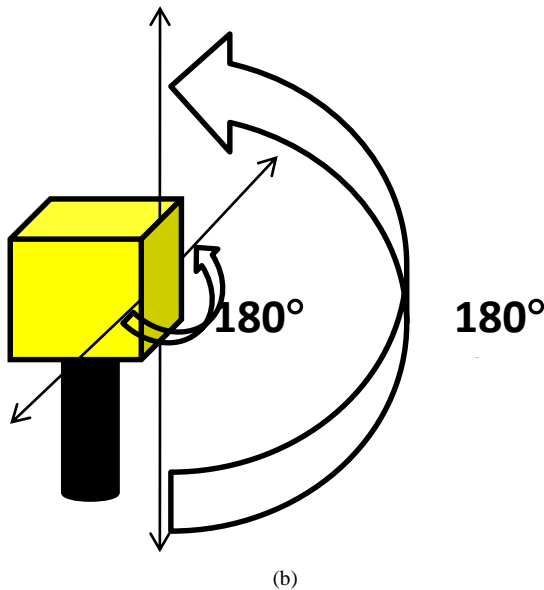

Figure 2 Original scanning area of the SICK PLS 101



(a)



(b)

Figure 3 (a) SICK PLS 101 laser scanner with servo motor; (b) the new hemispherical scanning area [17]

Table 2 Specification of SICK PLS 101 laser scanner [18]

Measuring range	Maximum 50 m
Scan area	Maximum 180°
Measuring error	± 50 mm
Response time	80 ms

To start collecting 3D interior data, several interiors were selected and scanned. Several types of rooms consisting of: an empty space with no clutter and occlusion; a sparse room with minimal clutter; a bigger room with a lot of clutter and occlusions; and a complex structure (i.e. complex indoor environment) were selected to test the sensor. Here, the term “sparse room” represents a cubic structure of a room (box-type) with plain objects (for example a bin or box) that would create simple clutter and occlusion problems. Meanwhile, the “complex indoor environment” term not only signifying real interiors with clutter, but also with complex geometry construction or composition. These aspects are taken into considerations as they typically represent the common scenario of any interior. The laser scanner was set to scan and collect 3D point cloud data of these rooms in a hemispherical range of view.

4.0 RESULTS AND DISCUSSIONS

Table 3 represents the 3D point cloud data collected for various interiors. Partial as well as full room interiors were chosen to test the workability of the sensor. It is shown that the sensor is capable to generate 3D data needed to reconstruct the 3D model representing the interior. Data collected here is in ASCII format, as this is universal format and can solve the proprietary issue circulating among building interior modelling, namely data format compatibility.

However, as this laser scanner is industrial-based, there are some considerations that need to be taken care of when using this to collect interior data:

• Low resolution

SICK PLS 101 does not provide as high a density of point cloud data as a current state-of-the-art laser scanner. However, the resolution provided by it is sufficient enough for the scope of generating 3D models of building interior. Plus, with a lower resolution, a smaller ASCII file size is generated, which will allow easier transferability. Data generated by the modern laser scanners are mainly 2GB in size on average, while the data collected by this sensor is within 2MB.

• Coverage area

The laser scanner can only gather 3D data within 180° area, compared to 360° coverage provided by the modern laser scanners. It is normal for a measurement system to be used outside its coverage area, and this is where the data registration method plays its part. This important task is about integrating the input while considering the coordinate system in which the data is being used. A modern laser scanner could face this problem too, especially when collecting data representing a huge environment. When this happens, a reference target with a unique form like a sphere or 'butterfly-shape' will be placed within the scanner's range and the laser scanner software will merge and combine the two data sets together when processing the data. In this work, a station marker is being placed to ensure the exact same location is being used to place the laser scanner when it is physically turned 180° to collect the second half of the interior data. As it works in a hemispherical view of range, it needs two scans to collect the data for the whole room if it is being placed at the center of the room. An 'X' is placed on the floor or carpet to mark the station marker, i.e. the location of the laser scanner. Apart from that, the SICK PLS 101 laser scanner has a shorter measuring range of 50 meters. However, based on the average size of a typical large room this is within the maximum range of this laser scanner, so this issue does not

affect the overall performance of this work. Figure 4 shows the location of the sensor during data collection process.

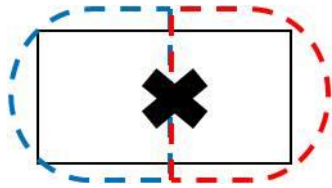

Figure 4 The location of the sensor during data collection. By placing it in the centre, it would allow all surfaces to be scanned

- **Noise data**

As seen in the results shown in Table 3, there is data that does not represent the real interior. This is noise data which exists

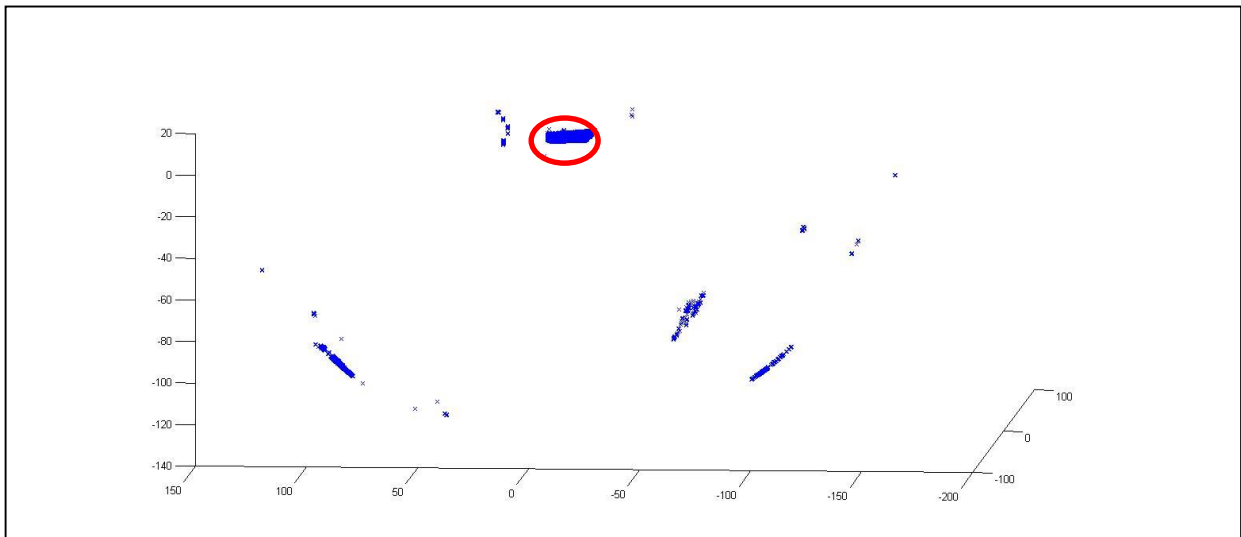

Figure 5 Data collected by a state-of-the-art laser scanner which also comes with noise data. Real interior data is shown in the red circle

due to the lower specification of the laser scanner. However, as this matter also arises when using a state-of-the-art laser scanner (refer to Figure 5), it can be referred to as a general issue. Suitable processing should be used to remove them [17].

5.0 CONCLUSIONS

This paper highlights on the optimization of SICK PLS 101 laser scanner from its industrial-based scope towards collecting 3D data representing building interiors. As current sensors in used for collecting this type of data have limitations, providing an alternate solution that will address these disadvantages is appreciated. Based on the above results, the sensor is sufficient to collect 3D data representing building interior for further modelling.

References







- [1] R. J. Whitaker, J. Gregor and P. F. Chen. 1999. Indoor Scene Reconstruction from Sets of Noisy Range Images. IEEE 2nd International Conference on 3D Digital Imaging and Modeling (3DIM 1999). Ottawa, Canada 4–8 October 1999.
- [2] U. Castellani, S. Livatino and R.B. Fisher. 2002. Improving Environment Modelling by Edge Occlusion Surface Completion. IEEE International Symposium on 3D Data Processing, Visualization and Transmission (3DPVT 2002). Padova, Italy 19–21 June 2002.
- [3] A. Gueorguiev, P. Allen, E. Gold and P. Blae. 2000. Design, Architecture and Control of a Mobile Site-modelling Robot. IEEE International Conference on Robotics and Automation (ICRA 2000). San Francisco, CA April 2000.
- [4] P. Allen, I. Stamos, A. Gueorguiev, E. Gold and P. Blae. 2001. AVENUE: Automated Site Modeling in Urban Environments. IEEE 3rd International Conference on 3D Digital Imaging and Modeling (3DIM 2001). Quebec City, Canada 28 May-1 June 2001.
- [5] F. Han, Z. Tu and S. C. Zhu. 2002. A Stochastic Algorithm for 3D Scene Segmentation and Reconstruction. In: A. Heyden *et al.* (eds.) Lecture Notes in Computer Science. Berlin Heidelberg: Springer-Verlag, 2002. 502–516.
- [6] A. Budroni and J. Boehm. 2009. Toward Automatic Reconstruction of Interiors from Laser Data. ISPRS 3rd International Workshop 3D-ARCH, Trento, Italy 25–28 February 2009.
- [7] B. Okorn, X. Xiong, B. Akinci and D. Huber. 2010. Toward automated Modeling of Floor Plans. 5th International Symposium on 3D Data Processing, Visualization and Transmission (3DPVT 2010). Paris, France 17–20 May 2010.
- [8] A. Adán and D. Huber. 2011. Reconstruction of Wall Surfaces Under Occlusion and Clutter in 3D Indoor Environments. Pittsburgh, Pennsylvania: Carnegie Mellon University. Available at: http://www.ri.cmu.edu/pub_files/2010/4/Report_A.Adan_D.Huber_A3_0_2010.pdf [Accessed 14 January 2011].
- [9] S. F. El-Hakim, P. Boulanger, F. Blais and J.A. Beraldin. 1997. A System for Indoor 3-D Mapping and Virtual Environments. Videometrics V. (3174). 21–35.
- [10] S. F. El-Hakim. 2001. 3D Modeling of Complex Environment. SPIE Electronic Imaging 2001. San Jose, California 21–26 January 2001.
- [11] S. Olufs and M. Vincze. 2010. Robust Room-structure Estimation in Manhattan-like Environments from Dense 2^{1/2}D Range Data. Bonn, Germany: University of Bonn. Available at: http://www.ais.uni-bonn.de/~holz/iros10wssm/proceedings/04_olufs_vincze_final.pdf [Accessed 8 November 2010].
- [12] D. Murray and J.J. Little. 2000. Using Real-time Stereo Vision for Mobile Robot Navigation. *Autonomous Robots*. 8: 161–171.
- [13] Y. Furukawa, B. Curless, S. M. Seitz and R. Szeliski. 2009. Reconstructing building interiors from images. International Conference on Computer Vision (ICCV 2009). Kyoto, Japan 29 September–2 October 2009.
- [14] A. K. Krishnan and K. M. Krishna. 2010. A Visual Exploration Algorithm Using Semantic Cues that Constructs Image Based Hybrid Maps. Bonn, Germany: University of Bonn. Available at: http://www.ais.uni-bonn.de/~holz/iros10wssm/proceedings/06_krishnan_final.pdf [Accessed 8 November 2010].
- [15] SICK Technical Description PLS – 07/98, SICK AG, Germany, 1998.
- [16] S. A. Abdul Shukor, K. Young & E. J. Rushforth. 2011. 3D Modeling of Indoor Surfaces with Occlusion and Clutter. IEEE International

Conference on Mechatronics. Istanbul, Turkey 13–15 April 201. 282–287.

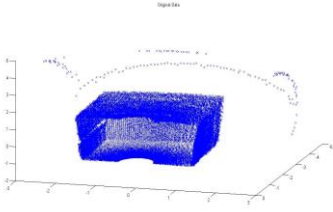
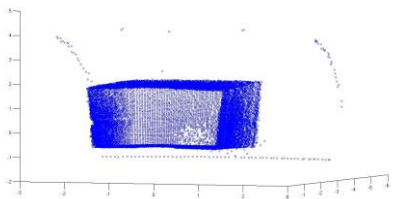
- [17] S. A. Abdul Shukor. 2013. A Geometrical-based Approach to Recognise Structure of Complex Interiors. Ph.D. dissertation, WMG, Univ. Warwick, Coventry, UK.

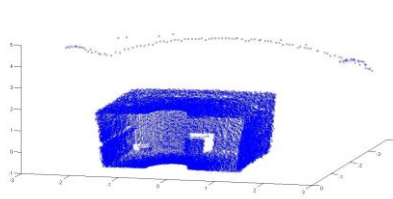
- [18] S. A. Abdul Shukor and K. Young. 2011. A fast Knowledge-based Plane Reconstruction Method from Noisy 3D Point Cloud Data. In: Hamza, M. H. & Zhang, J. J., eds. IASTED 12th International Conference on Computer Graphics and Imaging. Innsbruck, Austria 16–18 February 2011. 24–31.

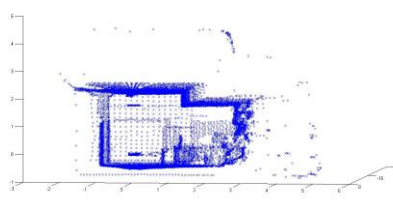
Table 3 Results of 3D data collected by SICK PLS 101 laser scanner

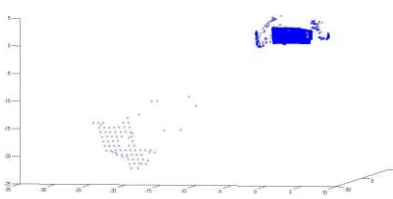
Room type	Figure of the room	Raw data collected by laser scanner
Empty		 25,438 points
		 25,430 points
Sparse		 25,470 points
Complex interior		 21,719 points
Complex interior		 50,829 points