

Gain Enhancement of Rectangular Microstrip Patch Antenna using Air Gap at 2.4 GHz

K. W. S. Al Kharusi¹, N. Ramli^{2*}, S. Khan³, M. T. Ali⁴ and M. H. Abdul Halim⁵

^{1,3}Faculty of Engineering and the Built Environment, SEGi University, Kota Damansara, Selangor, Malaysia.

²Center of Advanced Electrical and Electronics Systems (CAEES), Faculty of Engineering and the Built Environment, SEGi University, Kota Damansara, Selangor, Malaysia.

⁴Antenna Research Centre (ARC), Faculty of Electrical Engineering (FKE), Universiti Teknologi MARA (UiTM) Shah Alam, Selangor, Malaysia.

⁵Department of Science and Technology, International College of Technology Kanazawa, Kanazawa, Japan.

ABSTRACT

This project is carried out to design two antennas; one of them is a basic rectangular microstrip patch antenna and the other is the rectangular microstrip patch antenna added with an air gap technique for the main purpose of gain enhancement. Both antennas have been designed using RT5880 substrate because of its low dielectric constant at 2.2 and the permittivity of 0.0009. The proposed antennas were analysed and simulated at the frequency of 2.4GHz for WLAN application using the Computer Simulation Technology (CST) software. In order to increase the antenna's gain performance, a 3 mm air gap thickness was added in between the radiating patch element and the ground layer. From the simulation results, it was realized that the antenna's gain was enhanced from 6.907 dB (basic antenna) to 9.179 dB (antenna with 3 mm air gap) with 32.9% improvement, while the frequency is maintained at 2.4 GHz. Meanwhile, from the measurement results the gain improved 11.4% from 7.1 dB (basic antenna) to 7.91 dB (antenna with 3 mm air gap). However, the bandwidth decreased from 111.07 MHz (basic antenna) to 72.873 MHz (antenna with 3 mm air gap) from the simulation results. Both antennas prototype has been fabricated to validate the performance of the antennas. The simulated and measured results in terms of reflection coefficient, S_{11} , gain and VSWR are presented.

Keywords: Air Gap, Gain Enhancement, Low Dielectric, Microstrip, RT5880 Substrate.

1. INTRODUCTION

Nowadays, wired communication is becoming slowly but surely phased out as most of the applications use wireless communications. Antennas are so significant where people can convey the information to each other through air and space. An antenna is a manufactured radiating device that is used to emit electromagnetic waves. The properties of most transmitting antennas can be applied when acting as a receiver due to the duality of the antenna, where it is used in radio equipment to convert radio waves into electrical currents and vice-versa [1]. The main reason to choose microstrip antennas is because of its cost and ease of manufacturing as well as the flexibility itself that allows the characteristics required by the antenna.

The most well-known type of patch antenna is the microstrip antenna. Microstrip patch antennas consists of a thin patch (radiating element) on one side usually regarded as the top side of a dielectric substrate and the other side is a ground plane as shown in Figure 1. The patch is generally made from a high conducting material such as copper or gold. The radiating patch and feed lines are usually photoetched on the substrate. Microstrip antennas are generally

*Corresponding Author: azlinaramli@segi.edu.my

built to possess multiple geometrical designs as well as dimensions [2]. The substrate in microstrip antenna is primarily required for giving mechanical strength to the antenna. Moreover, substrate properties such as its dielectric constant, ϵ_r and loss tangent, δ have a pronounced effect on the antenna characteristics. The height and dielectric constant of the substrate are very important factors that influence the variation of bandwidth as well as the surface waves. The ones that are most preferred for antenna functionality are thick substrates whose dielectric constants are in the lower end of the range because they provide better efficiency, larger bandwidth and loosely bounded fields for radiation in space [3].

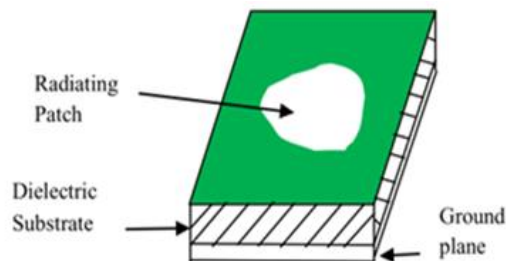

Figure 1. Illustration of a patch antenna [4].

In most applications, it is required to design an antenna with high gain characteristics in order to meet the long-distance communication demands. However, a major drawback of microstrip patch antennas are its narrow bandwidth and low gain [2]. Therefore, a few techniques have been applied on microstrip antennas to overcome this problem. The easiest known method to increase both the bandwidth and gain is by increasing the substrate thickness but only up to certain limit since they will decrease with the increasing dielectric constant caused by the thicker substrate. Another issue is this can cause the patch antenna to be quite thick which is undesirable in some cases. This problem can be solved by adding an air gap to increase thickness while keeping the dielectric constant low [5]. The thickness of the substrate can be increased in various ways such as by using stacked layer [6], air gap and slots [7].

The main reason of choosing an air gap technique is due to the effect of reducing the dielectric constant of the radiating plane and the effect of reducing the electric field concentration on the lossy epoxy [8]. In [9], 1 mm air gap was inserted to a square patch antenna which increased the gain from 3.36 dB (without air gap) to 4.65 dB and increased the bandwidth as well. In [10], the Frequency Reconfigurable Stacked Patch Microstrip Antenna (FRSPMA) using C-foam as a substrate is designed. The antenna is designed to operate at two different states. During the ON state, the antenna achieved the gain enhancement of 3.892 dBi and 6.553 dBi at 2.169 GHz (S-band) and 7.552 GHz (X-band). During OFF the state, the gain is 7.552 dBi at 6.53 GHz. In [11], a microstrip patch antenna is designed where air is used as a substrate by using electromagnetic band gap (EBG) structures at 2.42 GHz. The peak gains of E-plane at 2.42 GHz reaches 14.89 dBi. In addition, the total gain of the antenna increased to 10.45 dBi. However, the return loss increased to -12.5 dB because the EBG structures affect the impedance matching of the antenna. In [12], a circular patch antenna was used where the air gap is inserted between the two substrates. Before the addition of air gap, the circular patch antenna had gain of 6.41 dB and bandwidth of 5.32% of frequency band. The gain increased up to 8 dB and the bandwidth increased to 6.64 % during the addition of an air gap. In [13], it presented a dual band high gain miniaturized cross shaped patch antenna that is proposed for IEEE 802.11ax applications where the low-cost Flame Retardant 4 is used as a substrate. It can be seen the measured gain from 2.4 GHz and 5 GHz are respectively 6 dBi and 10 dBi.

In this paper, a design of two antennas; first is a basic rectangular microstrip patch antenna and second is the rectangular microstrip patch antenna added with an air gap technique is presented. The objectives are to improve or increase the antenna's gain and bandwidth

performance while maintaining the operating frequency at 2.4 GHz for a WLAN application. In section 2, the methodology concepts on the antenna specifications, designs on both antennas until the fabrication and measurement process are explained. In section 3, both antenna performance (basic antenna and antenna added with an air gap antenna) in terms of reflection coefficient, S_{11} , gain and bandwidth were compared between simulations and the results measured. Finally, the conclusions are presented in section 4.

2. METHODOLOGY

The methodological aspect of this work is outlined in this section.

2.1 Basic Rectangular Microstrip Patch Antenna Design

There are two antennas designed, the first one is a basic rectangular microstrip patch antenna while the other is the microstrip patch antenna added with an air gap. Before the start of designing the antenna, it is important to know the specification of an antenna as shown in Table 1. The antenna is required to have a S_{11} of less than -10 dB, a voltage standing wave between 1 and 2, the input impedance is to be set at 50 Ohms, while the patch and ground plane material is made from a copper with a thickness of 0.035 mm. Next, the selection of the substrate is important due to its noticeable effect on the antenna performance. In this project, the substrate used is Rogers RT5880 as it is a less lossy material when compared to the commonly used Flame retardant 4 (FR-4) substrate. The properties of Rogers RT5880 is shown in Table 2.

Table 1 Design specification of the antenna

Specification	Values
Frequency, f	2.4 GHz
Reflection coefficient, S_{11}	Less than -10 dB
VSWR	1:2
Input Impedance, Z	50 Ohms
Copper thickness, mm	0.035 mm

Table 2 Rogers RT5880 properties

Properties	Values
Dielectric Constant, ϵ_r	2.2 mm
Substrate Thickness (mm)	0.78 mm
Tangent loss, δ	0.0009

Next, a basic rectangular microstrip patch antenna is designed as shown in Figure 2 based on the calculation values obtained from the Equations (1)-(7) as listed below [14]. The dimensions of the antenna have been tabulated in Table 3 and the antenna has been designed in CST software to achieve the 2.4 GHz frequency. However, the frequency was not achieved at 2.4 GHz because the formulas did not counter the other losses instead of just the substrate material. Therefore, the dimensions of the basic antenna have been optimized until the operating frequency is resonant at 2.4 GHz as shown in Table 3.

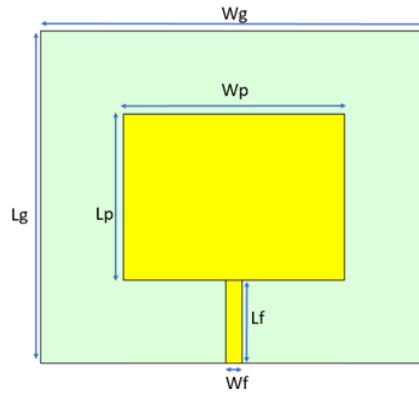

Figure 2. Parameters of patch antenna.

The width W_p and the length L_p of the patch are calculated using the equations given as [20]:

$$W_p = \frac{c}{2f_0 \sqrt{\frac{\epsilon_r + 1}{2}}} \quad (1)$$

where C is the speed of light = 3×10^8 m/s, $\epsilon_r = 2.2$ and $f_0 = 2.4$ GHz.

$$L_p = L_{\text{reff}} - 2\Delta L \quad (2)$$

where L_{reff} can be found using:

$$L_{\text{reff}} = \frac{c}{2f_0 \sqrt{\epsilon_{\text{reff}}}} \quad (3)$$

$$\epsilon_{\text{eff}} = \frac{\epsilon_r + 1}{2} + \frac{\epsilon_r - 1}{2} \left[1 + 12 \frac{h}{W} \right]^{-\frac{1}{2}} \quad (4)$$

In addition, ΔL can be found using:

$$\Delta L = 0.412h \left(\frac{\epsilon_{\text{reff}} + 0.3}{\epsilon_{\text{reff}} - 0.258} \right) \left(\frac{W/h + 0.264}{W/h + 0.813} \right) \quad (5)$$

The width and length of the ground plane can be found using:

$$W_g = 6h + W_p \quad (6)$$

$$L_g = 6h + L_p \quad (7)$$

where h is the height of the substrate.

Table 3 Numerical dimensions of basic rectangular microstrip patch antenna

Parameter	Width, W_p	Length, L_p	Ground width, W_g	Ground length, L_g	Feedline width, W_f	Feedline Length, L_f
Calculated (mm)	49.38	41.77	54.06	49.38	2.21	2.34

From Figure 3, it can be observed that the antenna designed with the calculated values does not resonant at 2.4 GHz but it drops at 2.38 GHz. This is because the formulas did not counter other

losses like in CST software, but it just considered the specification of the substrate. Therefore, the dimensions of the basic antenna have been optimized until the operating frequency is resonant at 2.4 GHz as shown in Table 3. The basic structure of rectangular microstrip patch antenna that has been designed using CST is shown in Figure 4.

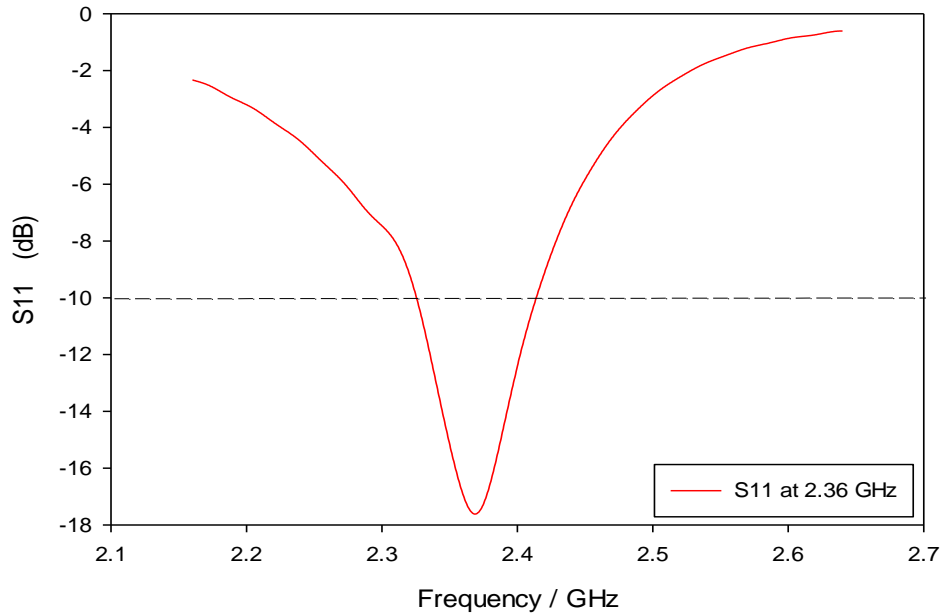

Figure 3. Initial antenna reflection coefficient based on numerical calculations.

Table 3 Optimization dimensions of basic rectangular microstrip patch antenna

Parameter	Width, Wp	Length, Lp	Ground width, Wg	Ground length, Lg	Feedline width, Wf	Feedline Length, Lf
Optimized (mm)	70	41.05	80	60	2.29	9.475

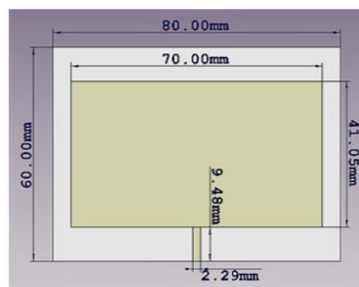

Figure 4. Basic structure of rectangular microstrip patch antenna using CST.

2.2 Design of Rectangular Microstrip Patch Antenna added with an Air Gap Technique

One of the techniques that has been used to increase the antenna's gain is by using the air gap technique. Air gap technique is a technique where the thickness of the substrate can be increased by inserting an air gap in between the radiating element and the substrate or by inserting an air gap between the ground plane and the substrate as shown in Figure 5 [15]. Figure 6 shows the structure of a rectangular microstrip patch antenna with 3 mm air gap design and Table 4 shows the optimization dimensions for the proposed design.

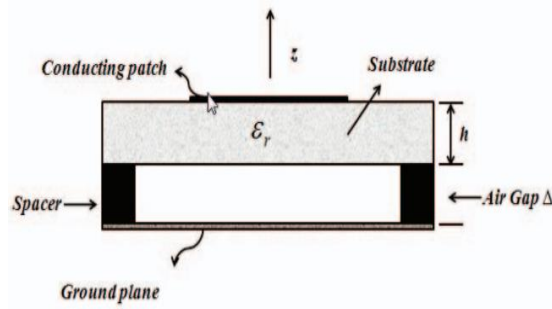

Figure 5. Patch antenna with air gap [15].

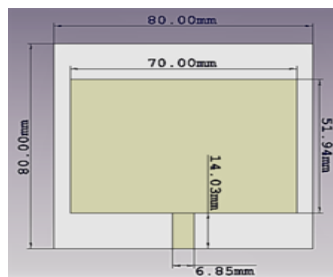

Figure 6. The structure of the rectangular microstrip patch antenna added with 3 mm air gap.

Figure 7 and Table 4 show the effects of the frequency and reflection coefficient values whenever the air gap has varied from 1 mm to 10 mm. As the air gap thickness changes from 1 mm to 10 mm, the S_{11} values change as well as the gain changes. It can be observed that, the frequency varies with the change of thickness from 1 mm to 6 mm and the gain also increased. However, when the air gap varies from 7 mm to 10 mm thickness, the frequency was resonant at 2.42 GHz. Therefore, the 3 mm air gap thickness has been chosen for the design because the gain is 9.18 dB while the S_{11} is -48.1 dB at the operating frequency of 2.40 GHz. Finally, the dimension of the basic rectangular microstrip patch antenna added with 3 mm air gap has been shown in Table 5 and Figure 8.

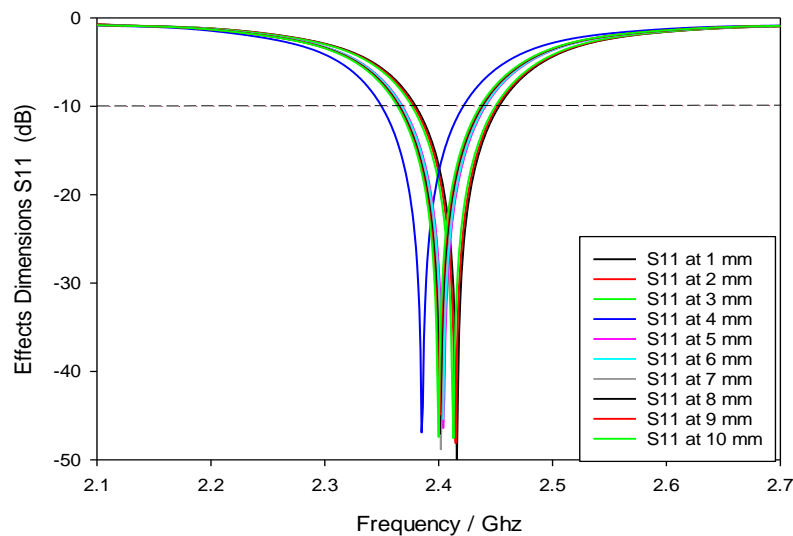

Figure 7. The effects of various air gaps thickness from 1mm to 10mm.

Table 4 Effects of various air gaps thickness from 1mm to 10 mm

Air Gap (mm)	Frequency (GHz)	S ₁₁ at 2.4 GHz	Gain (dB)
1	2.42	-46.1	8.68
2	2.42	-42.6	9.07
3	2.40	-48.1	9.18
4	2.38	-45.6	9.21
5	2.41	-47.1	9.21
6	2.45	-40.7	9.13
7	2.42	-39.1	8.96
8	2.42	-48.1	8.76
9	2.42	-49.2	8.51
10	2.42	-50.0	8.18

Table 5 Dimensions of a rectangular microstrip patch antenna added with a 3mm air gap

Parameter (mm)	Width, Wp	Length, Lp	Ground width, Wg	Ground length, Lg	Feedline width, Wf	Feedline Length, Lf
Antenna with 3mm Air Gap (mm)	70	51.94	80	80	6.85	14.03

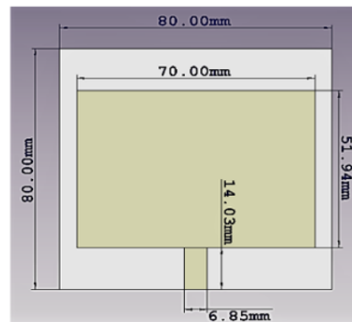

Figure 8. Dimensions of rectangular microstrip patch antenna added with a 3 mm air gap using CST.

2.3 Fabrication

Final antennas design was fabricated using the Rogers RT 5880 board. A computer numerical control machine is used to aid with fabrication of the antennas in order to minimise defects in the fabrications, since the series of steps needed to produce any part is highly automated the produced part is closely matched to the original CAD. The PCB layout of the board can be directly taken from the CST software and converted into a DXF file, this allows the design structure to be opened via a computer-aided design and drafting (CAD) software. An SMA port is soldered to the feedline and ground of the completed antenna. There are many types of SMA connectors all depending on the type of application required. For this type of antenna, a female SMA port is used, it has 50 ohms line impedance and small VSWR.

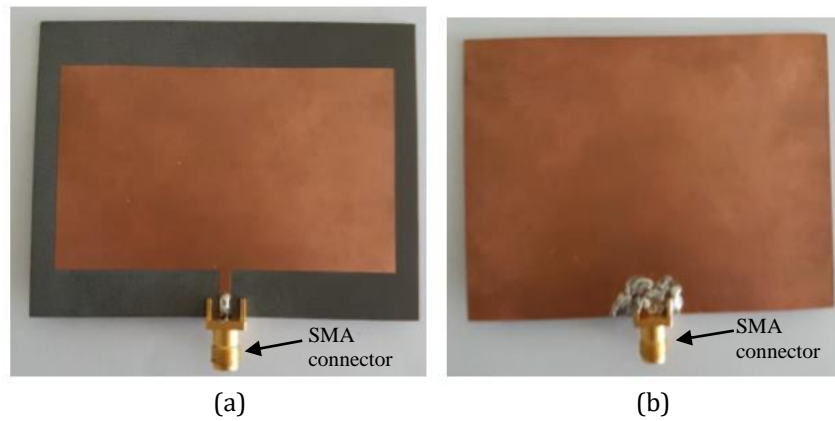

Figure 9. Fabricated of a basic rectangular microstrip patch antenna (a) front view, (b) back view.

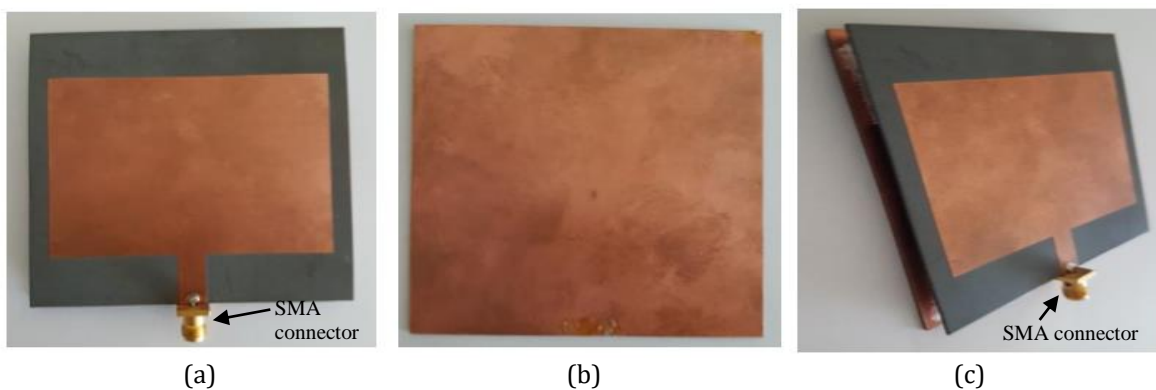

Figure 10. Fabricated of antenna with a rectangular microstrip antenna with a 3mm air gap (a) front view, (b) back view, and (c) side view.

2.4 Measurement Setup

The measurement for reflection coefficient and radiation pattern are done on the fabricated antennas. The measurements are taken to validate the performance of the fabricated antennas between the simulation and measurement. The two types of measurement setup are explained in this section. All measurements were done at the Antenna Research Centre (ARC) lab at UiTM Shah Alam.

2.4.1 Reflection Coefficient Measurement

A vector Network Analyser (VNA) is used to measure the reflection coefficient S_{11} parameter it saves the result in a touchstone format. The equipment consisted of the microstrip antenna being tested and the VNA device. Figure 11 shows the antenna connected to the Keysight Fieldfox N9916A microwave analyser that can measure from 5KHz to 14GHz.

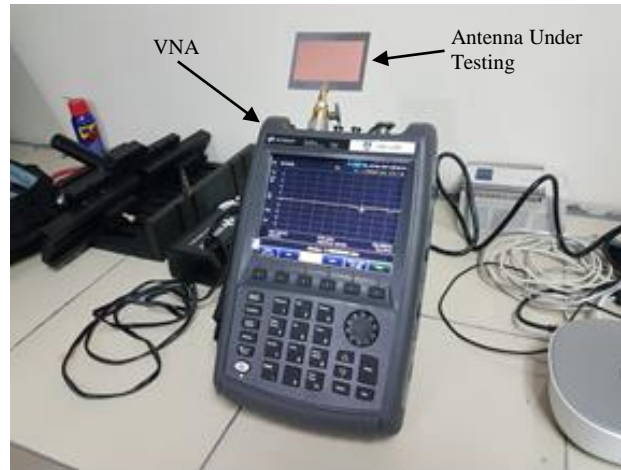

Figure 11. Reflection Coefficient, S_{11} Measurement setup.

2.4.2 Radiation Pattern Measurement

The radiation pattern was measured in an anechoic chamber as shown in Figure 12. The antenna is connected through a vertical positioned holder, which rotates the antenna in the azimuth plane. The test antenna acts as a transmitter transmitting to the receiver at the end of the chamber. Figure 12 shows the radiation pattern measurement setup in Solidbase Technology Atenalab OTA-500 anechoic chamber.

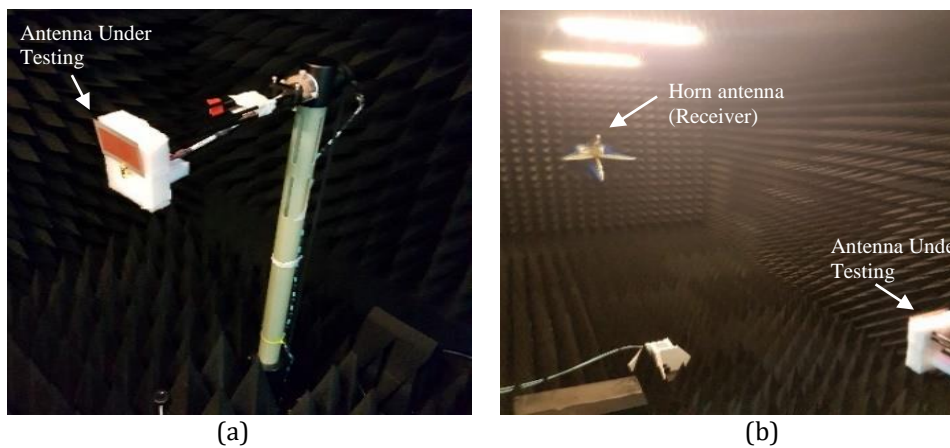

Figure 12. Radiation pattern measurement setup in anechoic chamber (a) antenna under testing (AUT) (b) AUT and receiver antenna.

3. RESULTS AND DISCUSSION

Figure 13 shows the reflection coefficient, S_{11} achieved -23.8 dB for the basic rectangular microstrip patch antenna at the simulated resonant frequency of 2.4 GHz. Whereas, in Figure 14 it can be observed that the antenna which was added with 3 mm air gap thickness achieved -48.88 dB of reflection coefficient, S_{11} at the desired frequency. The voltage standing wave ratio (VSWR) for both antennas are between 1 ratio 2 and it has a capability to operate at 2.4 GHz application.

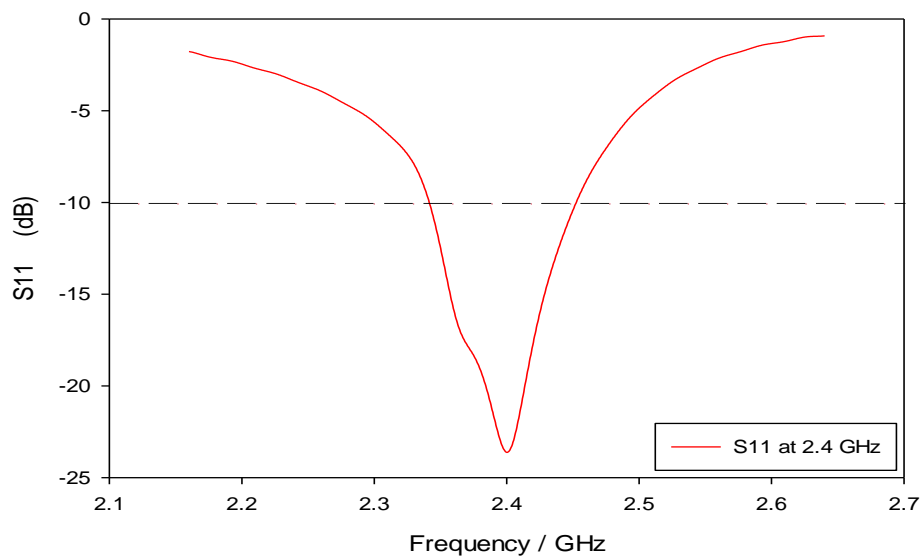

Figure 13. Simulation Results of Reflection Coefficient, S_{11} for basic rectangular microstrip antenna at 2.4 GHz.

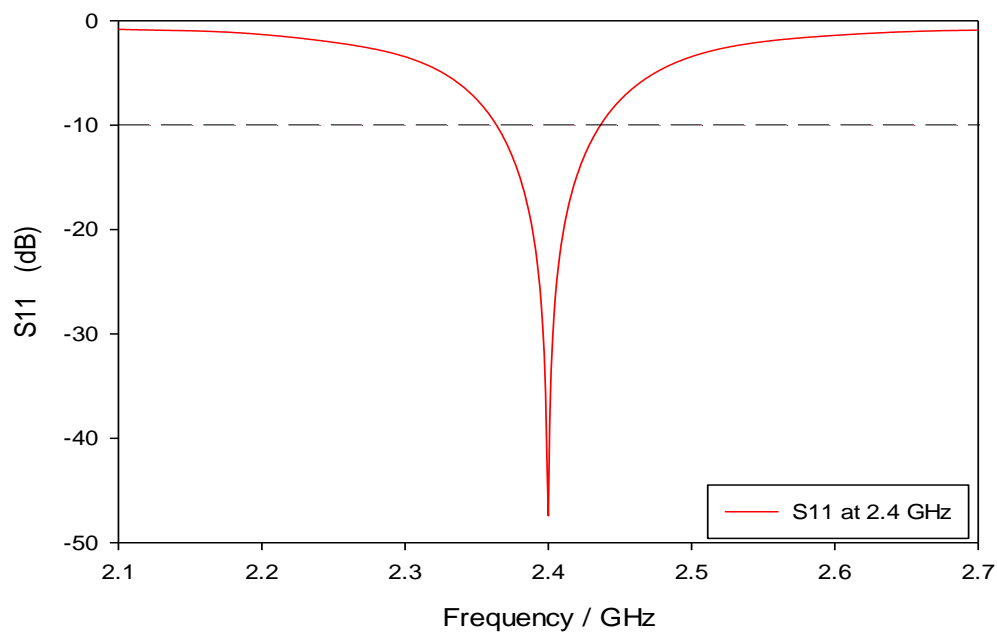

Figure 14. Simulation Results of Reflection Coefficient, S_{11} of a rectangular microstrip antenna added with a 3 mm air gap at 2.4 GHz.

By using the CST simulation software, the 3D view of the farfield radiation pattern of the basic antennas and antenna with 3 mm air gap are shown in Figure 15 and Figure 16. The 3D farfield plot clearly shows that the direction of radiation is directional to 0° , which is shown to radiate primarily to the front of the patch antenna. Besides that, the graph also indicates the value of gain of the antennas. It can be observed that the simulated gain of the basic rectangular microstrip antenna was 6.907 dB, while the microstrip antenna with air gap is 9.18 dB. This shows that air gap has increased the gain of the antenna by 2.27 dB and in percentage it increased by 32.91%. However, the bandwidth performance decreased from

111.07 MHz (basic antenna) to 72.873 MHz (antenna with 3 mm air gap) from the simulation results.

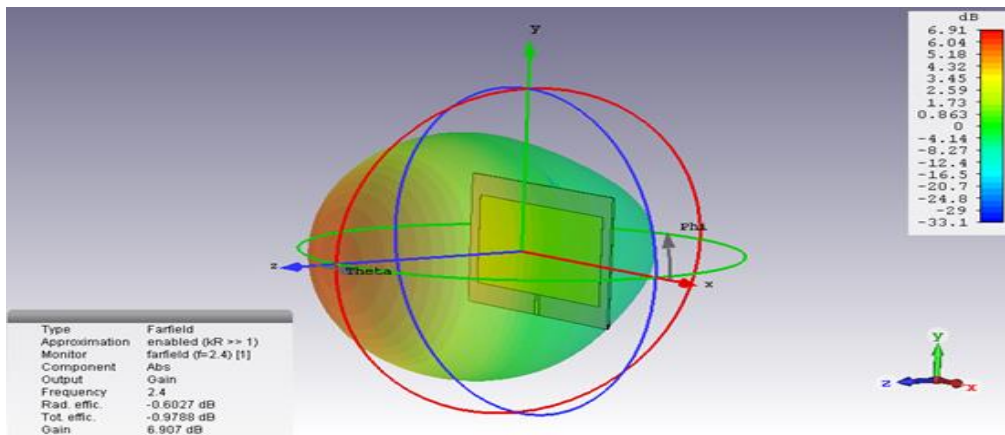

Figure 15. 3D view of radiation pattern for a basic rectangular microstrip patch antenna.

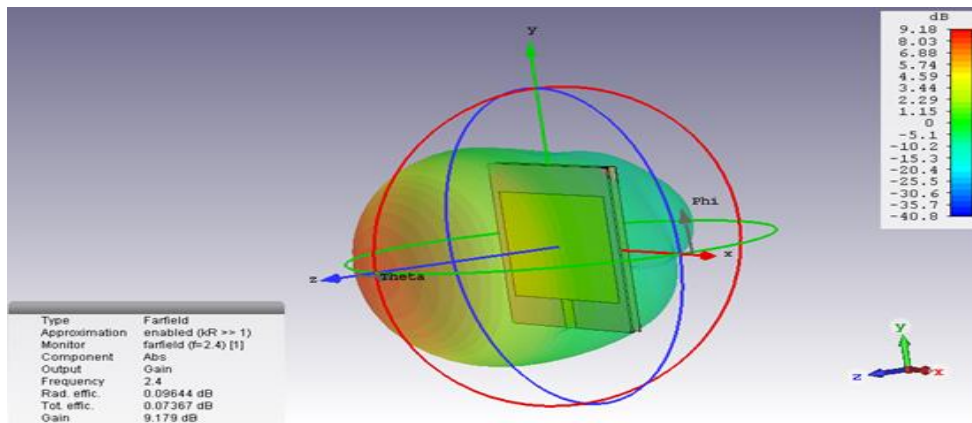

Figure 16. 3D view of radiation pattern for rectangular microstrip patch antenna added with a 3 mm air gap.

Figure 17 shows the measured reflection coefficient of the fabricated antenna without air gap was obtained from the VNA machine. It shows that the antenna does drop at the required frequency of 2.4 GHz. However, it does not reach the requirement of having reflection coefficient, $S_{11} < -10$ dB. This could be due to many factors like machining errors/defect during the fabrication or effect from the soldering part at the SMA connector.

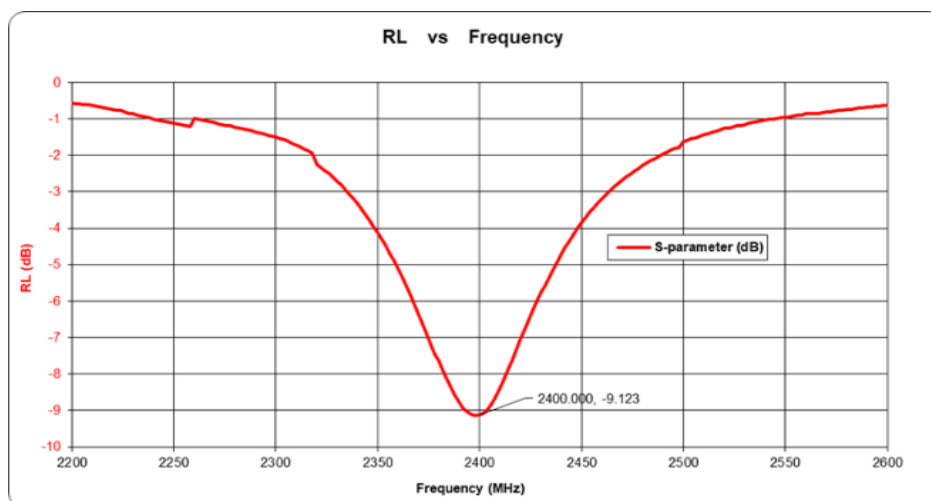

Figure 17. Reflection coefficient of fabricated antenna for a basic rectangular microstrip patch antenna.

As it can be seen from Figure 18, the measured reflection coefficient of the fabricated antenna with 3 mm air gap has reached a value of -23.004 dB which satisfies the requirement of $S_{11} < -10$ dB. However, the frequency shifted to 2.45 GHz instead of the desired frequency at 2.4 GHz. This is acceptable since it still supports 2.4 GHz with the reflection coefficient value being -10.9 dB.

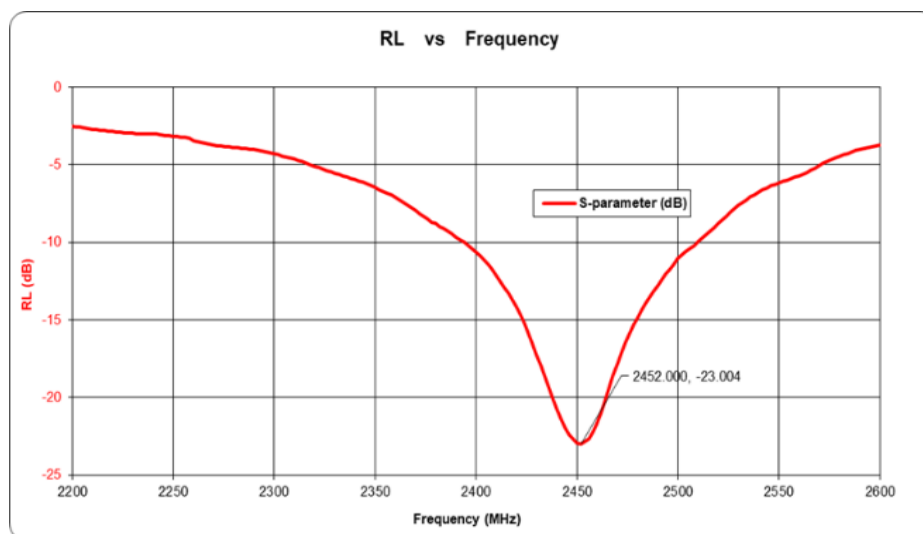

Figure 18. Reflection coefficient of fabricated rectangular microstrip patch antenna added with 3 mm air gap.

Table 6 shows the comparison results of simulated and fabricated antennas for both designs. For simulated results, the gain has been from 6.907 dB (basic antenna) to 9.179 dB (with 3 mm air gap) while the frequency is maintained at 2.4 GHz. While for the measured values, it was proven that the antenna's gain was enhanced from 7.1 dB (basic antenna) to 7.91 dB (with 3 mm air gap). The VSWR value of the proposed antenna is less than the maximum acceptable value (1:2). In both the cases, the overall gain of the antenna increased while operating at the desired frequency of 2.4 GHz.

Table 6 Comparison results of simulated and fabricated antennas

Specifications	Basic Rectangular Microstrip Antenna		Rectangular Microstrip Antenna added with 3 mm air gap	
	Simulated	Measured	Simulated	Measured
Frequency	2.4 GHz	2.4 GHz	2.4 GHz	2.45 GHz
Reflection coefficient, S ₁₁	-23.8 dB	-9.123 dB	-48.88 dB	-23 dB
VSWR	1.808	1.82	1.16	1.12
Gain	6.907 dB	7.1 dB	9.179 dB	7.91 dB

4. CONCLUSION

It is proven that by adding an air gap to the basic rectangular microstrip antenna, the gain increased by 32.9% (from 6.907 to 9.179 dB) for simulated results and 11.4% (from 7.1 to 7.91 dB) for measured results. Both antennas achieved a good VSWR between 1:2 that confirmed the antennas were not dummy but its suitable to support WLAN application at 2.4 GHz frequency application. Overall, the antenna with 3 mm thickness fulfill all the antenna's specification such as reflection coefficient, gain and VSWR. However, the only drawback found is that the antenna with air gap caused an increase in the total thickness dimension from 0.857 mm (basic antenna) to 3.857 mm (antenna with 3 mm air gap), which is sometimes undesirable since one of the reasons of using microstrip antenna is its small size.

ACKNOWLEDGEMENTS

The authors would like to thank SEGi University for sponsoring the financial support. The appreciation also is given to the Centre of Advanced Electrical and Electronics Systems (CAEES), SEGi University and Antenna Research Centre (ARC), Universiti Teknologi MARA, Shah Alam for support in obtaining the information, material and development of our work.

REFERENCES

- [1] P. Scholz, "Basic Antenna Principles for Mobile Communications," (2011) 1–46.
- [2] R. Garg, P. Bhartia, I. Bahl, & A. Ittipiboon, *Microstrip Antenna Design Handbook*. Boston, MA: Artech House, (2001).
- [3] M. R. Hasan & A. S. Abdulla, "Substrate Height and Dielectric Constant Dependent Performance of Circular Micro Strip Patch Array Antennas for Broadband Wireless Access," *J. Emerg. Trends Comput. Inf. Sci.* **3**, 10 (2011) 1392–1397.
- [4] I. Singh & V. Tripathi, "Micro strip Patch Antenna and its Applications: a Survey," *Int. J. Comp. Tech. Appl* **2**, 5 (2011) 1595–1599.
- [5] R. D. Mishra & P. K. Singhal, "Gain Enhancement of Rectangular Microstrip Patch Antenna Designed for Exposure System Using Microstrip Array," **9**, 5 (2016) 417–430.
- [6] N Ramli, MT Ali, AL Yusof, S Muhamud-Kayat, AAA Aziz, "PIN diode switches for frequency-reconfigurable stacked patch microstrip array antenna using aperture-coupled technique," *Asia-Pacific Microwave Conference Proceedings (APMC)*, (2013) 1052-1054.
- [7] S Muhamud Kayat, MT Ali, MKM Salleh, N Ramli, MHM Rusli, "Reconfigurable truncated rhombus-like microstrip slotted antenna with parasitic elements," *2013 7th European Conference on Antennas and Propagation (EuCAP)*, (2013) 898-902.
- [8] S. S. Singh & S. R. Bhujade, "Design and Evaluation of High Gain Microstrip Patch Antenna Using Double Layer with Air Gap," *Int. J. Recent Innov. Trends Comput. Commun.* **3**, 3 (2015) 1678–1681.

- [9] D. Bhardwaj, Komal, D. Bhatnagar, & S. Sancheti, "Square patch microstrip antenna with single notch having an air gap," 2008 Int. Conf. Recent Adv. Microw. Theory Appl. Microw. no. f 1 (2008) 910–912 .
- [10] N Ramli, MT Ali, AL Yusof, S Muhamud Kayat, H Alias, MA Sulaiman, "A frequency reconfigurable stacked patch microstrip antenna (FRSPMA) using C-Foam in stacked substrate," IEEE Asia-Pacific Conference on Applied Electromagnetics (APACE), (2012) 322-326.
- [11] Nathapat Supreeyatitikul & Niruth Prombutr, "Gain Enhancement of Microstrip Patch Antenna using an Electromagnetic Band Gab Structure at 2.4GHz", International Conference on Electrical and Electronic Engineering (ICEEE), (2018) July 5 -6.
- [12] T. V. S. Divakar, "Gain and Bandwidth Enhancement of a Circular between Two Substrates," (2013) 7–8.
- [13] P. Rajalakshmi & N. Gunavathi, "Gain Enhancement of Cross Shaped Patch Antenna for IEEE 802.11ax Wi-Fi Applications", Progress in Electromagnetics Research Letters, **80** (2018) 91–99.
- [14] C. A. Balanis, "Antenna theory: a review," Proc. IEEE **80**, 1 (1992) 7–23.
- [15] Y. Mao, "Air Gap Tuninnng of Patch Antenna Resonance," IEEE International Symposium on Antennas and Propagation (APSURSI), (2011) 3088–3090.