

Fuzzy Logic Control for Non Linear Car Air Conditioning

Mohd Fauzi Othman* and Siti Marhainis Othman

Department of Control and Instrumentations, Faculty of Electrical Engineering,
Universiti Teknologi Malaysia
81310 UTM Skudai, Johor, Malaysia.

*Corresponding author: fauzi@fke.utm.my (Mohd Fauzi Othman), Tel: 607-5535330, Fax: 607-5566272

Abstract: A practical application of a fuzzy control system for a non-linear air conditioning system in the automobile climate control system was carried out and the simulation results are presented. Temperature control in an automobile passenger environment is more complex than that of a static room in a building. With regards to both driver and passenger comfort and safety, a lot of factors must be taken in account. Therefore, the objective of this paper is to study the implementation of fuzzy logic control in automobile climate control system compared to the existing state flow controller.

Keywords: Automobile, Air conditioner, Climate control system, Temperature control.

1. INTRODUCTION

Non-linear characteristic is a problem in temperature control of air conditioning. State flow controller uses different approximation methods to handle non-linearity [1]. Some typical choices are linear, piecewise linear, and lookup table approximations to trade off factors of complexity, cost, and system performance [2].

A linear approximation technique is relatively simple, however, it tends to limit the control performance and may be costly to implement in certain applications. A piecewise linear technique works better, although it is tedious to implement because it often requires the design of several linear controllers. A lookup table technique may help improve control performance, but it is difficult to debug and tune. Furthermore, in complex systems where multiple inputs exist, a lookup table may be impractical or very costly to implement due to its large memory requirements.

Fuzzy logic provides an alternative solution to non-linear control because it is closer to real world [3]. Non-linearity is handled by rules, membership functions and inference process, which results in improved performance, simpler implementation and reduced design costs [4-6]. Most control applications have multiple inputs and require modeling and tuning of a large number of parameters, which makes implementation very tedious and time consuming. Fuzzy rules can simplify the implementation by combining multiple inputs into single if-then statements while still handling non-linearity.

2. DEVELOPMENT OF AN AUTOMOBILE AIR CONDITIONER USING STATE FLOW AS CONTROLLER

Figure 1 depicts a model that interfaces the vehicle climate control system with a model of the electrical system to examine the loading effects of the climate

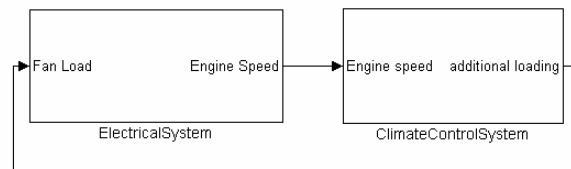

Figure 1. Vehicle electrical and climate control system

control systems on the entire electrical systems of a car [7].

Figure 2 is an electrical system. This electrical system models the car at idle speed. The PID controllers ensure that the car's alternator (modeled by a simplified synchronous machine which has its field current regulated to control the output voltage) is also operating at the required speed. The output of voltage is then fed through a three phase 6 pulse diode bridge to supply the voltage needed to charge the battery which supplies the voltage for the car's DC bus.

The power supply for the fan obtained from the DC bus is also used to power the windscreen wipers, radio, etc. The speed of the fan and thus the loading on the DC bus, are proportional to the difference between the set (or reference) temperature and the actual temperature inside the car. The inclusion of feedback in the electrical system ensures that regardless of the load, the voltage on the bus remains at a constant 12V.

The changing of the input voltage to the engine is modeled as a DC machine in the car's electrical model. By changing the input voltage, we are able to see how the speed of the engine changes without affecting the voltage on the DC bus.

Figure 3 is a climate control system which uses state flow as a controller. A user can choose the temperature in the car by double click the *User Set point In Celsius*

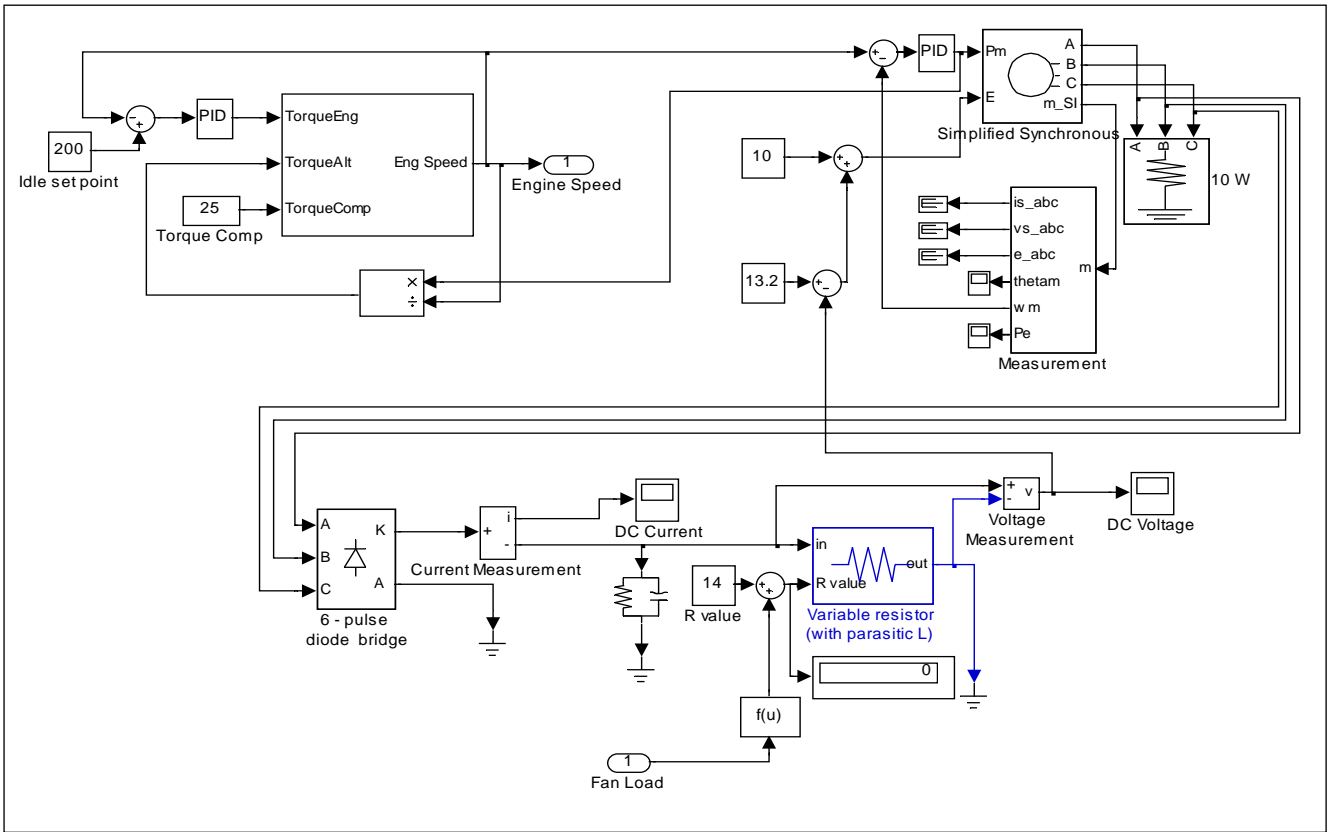

Figure 2. The car electrical system

Block and entering the value into the dialog box. The *External Temperature in Celsius* can also be set by the user in a similar way.

The numerical display on the right hand side of the model shows the reading of a temperature sensor placed behind the driver's head. This is the temperature that should be felled by a driver. When the model is run and the climate control is active, this box displays the change of temperature in the car.

There are two fuzzy logic controllers used in this model. Figure 4 is the climate control system which uses fuzzy logic as controller. FLCBLOWER is used to control blower speed proportion based on the range of difference between the set point and current temperatures and the number of passengers in the cabin. The speed of the blower will be proportional to the temperature differences. But, the blower speed proportion values are also influenced by the number of passengers. Meaning that, although the range of temperature difference is the same, the output changes if the number of passengers in the car is changes. The blower speed proportion will increase when the number of passengers increases.

FLCSWITCH is used to switch either *AC State* or *Heater State* depending on the temperature difference values; either negative or positive. If the difference is negative, it means that the set point temperature is less than the current temperature; therefore the air conditioning state will be switched on. If the difference is positive, this means that the set point temperature is larger than the current temperature, therefore, the heater

state will be switched on. When the difference is zero, both of the states will be switched off by the fuzzy logic controller and the desired state will be maintained until the user changes the values.

3. CONTROLLER DESIGN

Figure 5 is a *structure* of the fuzzy controller for the automobile climate control system. In this stage, the process input and output variables are also determined.

A single fuzzy controller can have multiple inputs depending on the need of the control system. For FLCBLOWER, the inputs are the range of temperature difference, a , and the power provided by the number of passengers, b , and the output is blower speed proportions, d . Figure 6, Figure 7, and Figure 8 describe the operation for FLCBLOWER. For FLCSWITCH, the input is the range of temperature difference, a , and the outputs, c , are switched to either *Heater* or *AC State*. T_1 is the exit temperature from both states and T_2 is the internal temperature. Figure 9, Figure 10, and Figure 11 show the operation of FLCSWITCH.

4. RESULTS AND ANALYSIS

Figure 12 shows the results of the simulation model that uses state flow as controller. The results in Figure 12 (a) and Figure 12 (b) prove that the desired temperature of 17°C and 25°C, respectively, can not be achieved by the controller. This is because state flow is off either in the air conditioning control or heater control when the current temperature in the car is 0.5°C above or low than the set

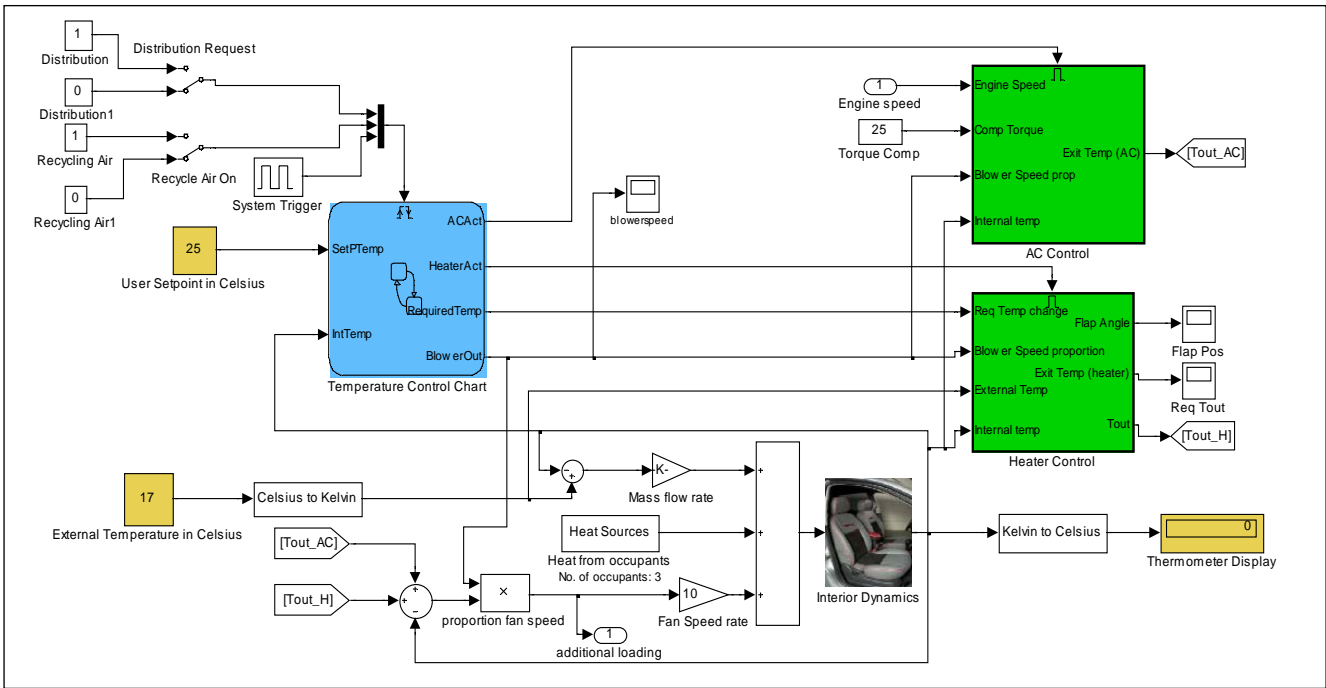

Figure 3. Climate control systems using state flow as a controller

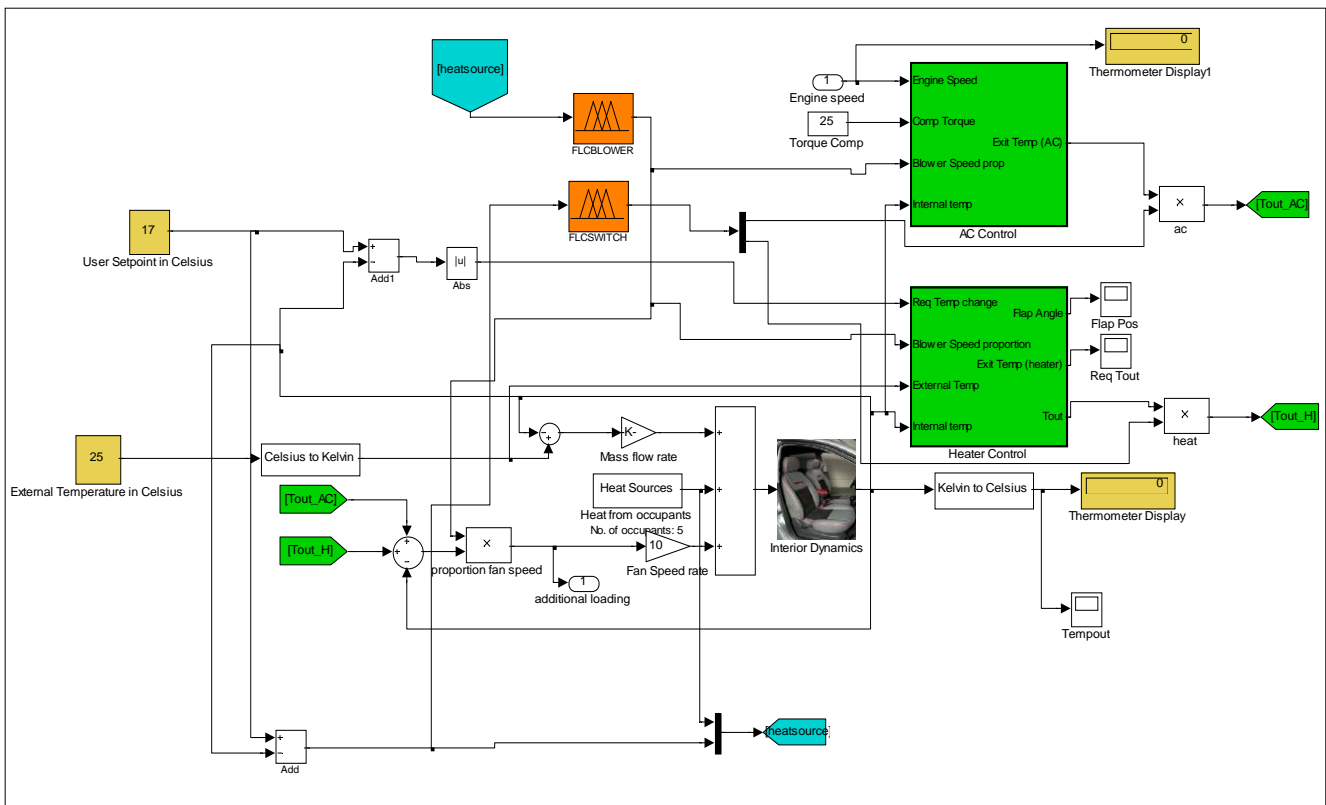

Figure 4. Climate control systems using fuzzy logic as a controller

point temperature. The dead band of 0.5°C has been implemented to avoid the problem of continuous switching.

Figure 13(a) and Figure 13(b) show the result of the simulation models that use fuzzy logic as controller. The result showed in Figure 13 (a) and Figure 13 (b) prove that the desired temperatures, which are 17°C and 25°C ,

respectively, have been achieved by the fuzzy controller. The desired temperature has been maintained by the controller because fuzzy logic has switched off either the air conditioning control or heater control when the temperature difference between set point and current temperatures is between -0.0001°C and 0.0001°C .

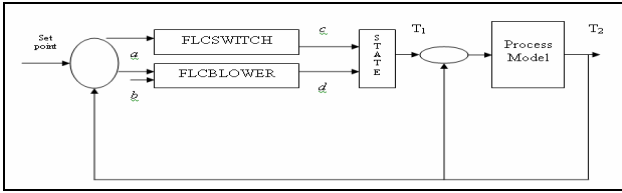
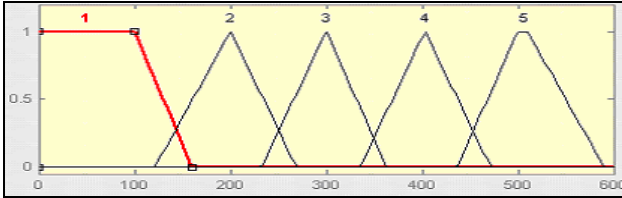
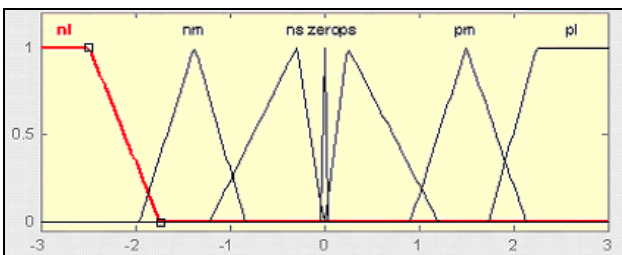

Figure 5. Configuration of fuzzy logic control automobile climate control system



(a)



(b)

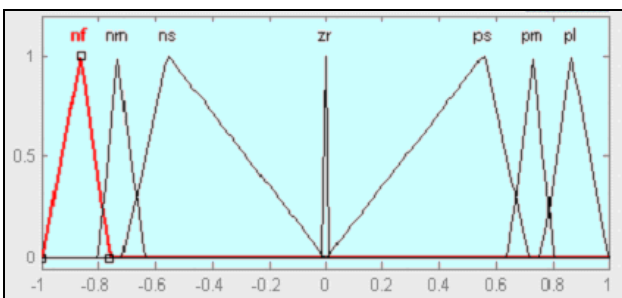

(c)

Figure 6. Membership function for FLCBLOWER
 (a) Input : Heat (n) (b) Input : temperature difference
 (c) Output: blower speed

The number of passengers does not affect the performance of fuzzy logic controller because the rule base that has been used has the capability to manage until 5 passengers. In addition, the accurate blower speed proportion values can be achieved according to the desired temperature in order to provide a comfortable condition to the driver and passengers.

As shown in Figure 14 (a) and Figure 14 (b), fuzzy logic controller has a better overall performance compared to the state flow controller. In Figure 14 (a), at the beginning of the simulation, both controllers did perform well but when the temperature reaches 17.35°C, the state flow controller response becomes slow. This is because, state flow have to wait for the current temperature to increase to 17.5°C, which makes the difference values out within

Type	Number	Quantization level
Input 1: Heat (N)	5	- 1 (Very small) - 2 (Small) - 3 (Medium) - 4 (Large) - 5 (Very large)
Input 2: Temperature difference	7	- Negative large (NL) - Negative medium (NM) - Negative small (NS) - Zero (ZR) - Positive small (PS) - Positive medium (PM) - Positive large (PL)
Output: Blower speed	7	- Negative fast (NF) - Negative medium (NM) - Negative slow (NS) - Zero (ZR) - Positive slow (PS) - Positive medium (PM) - Positive fast (PF)

Figure 7. Quantization for FLCBLOWER

TD\N	VS	S	M	L	VL
NL	PS	PS	PM	PM	PF
NM	PS	PS	PS	PM	PM
NS	PS	PS	PS	PS	PS
ZR	ZR	ZR	ZR	ZR	ZR
PS	NS	NS	PS	NS	NS
PM	NS	NS	PS	NM	NM
PL	NS	NS	PM	NM	NF

Figure 8. Rule base for FLCBLOWER

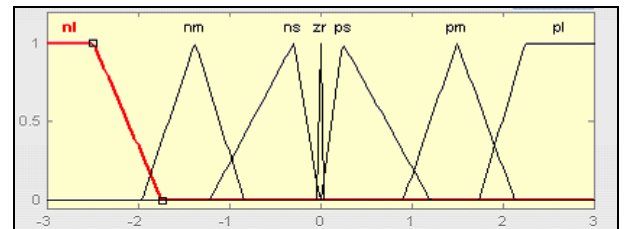

Figure 9. Membership function for FLCSWITCH

Type	Number	Quantization level
Input 1: Temperature difference	7	- Negative large (NL) - Negative medium (NM) - Negative small (NS) - Zero (ZR) - Positive small (PS) - Positive medium (PM) - Positive large (PL)
Output 1: Switch AC	2	- on (ONE) - off (ZERO)
Output 2: Switch HEATER	2	- on (ONE) - off (ZERO)

Figure 10. Quantization for FLCSWITCH

TD\N	Switch AC	Switch Heater
NL	on	off
NM	on	off
NS	on	off
ZR	off	off
PS	off	on
PM	off	on
PL	off	on

Figure 11. Rule base for FLC SWITCH

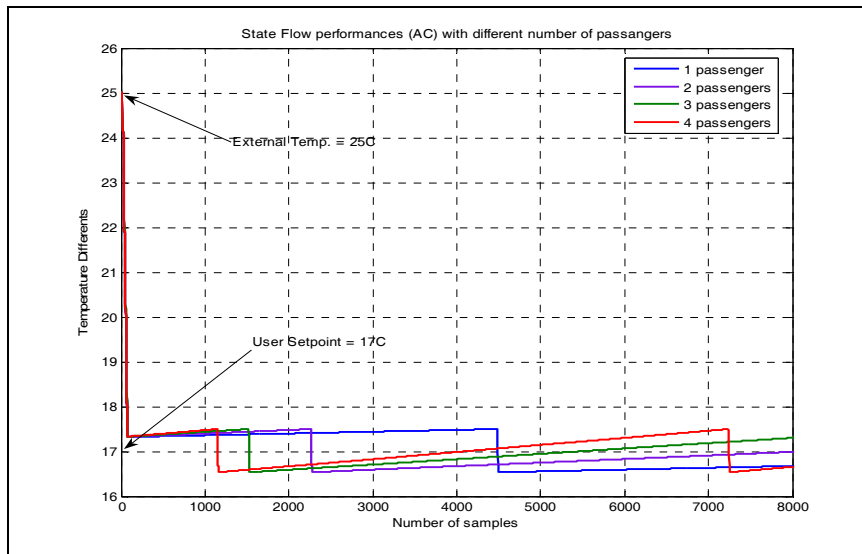

(a)

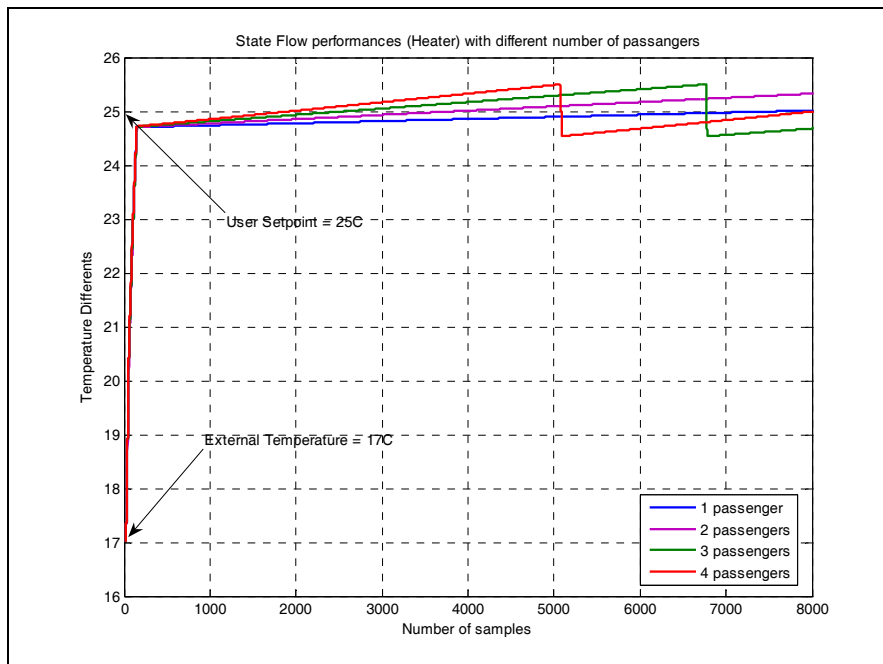

(b)

Figure 12. (a) State flow performance (AC) with different number of passengers (b) State flow performance (HEATER) with different number of passengers

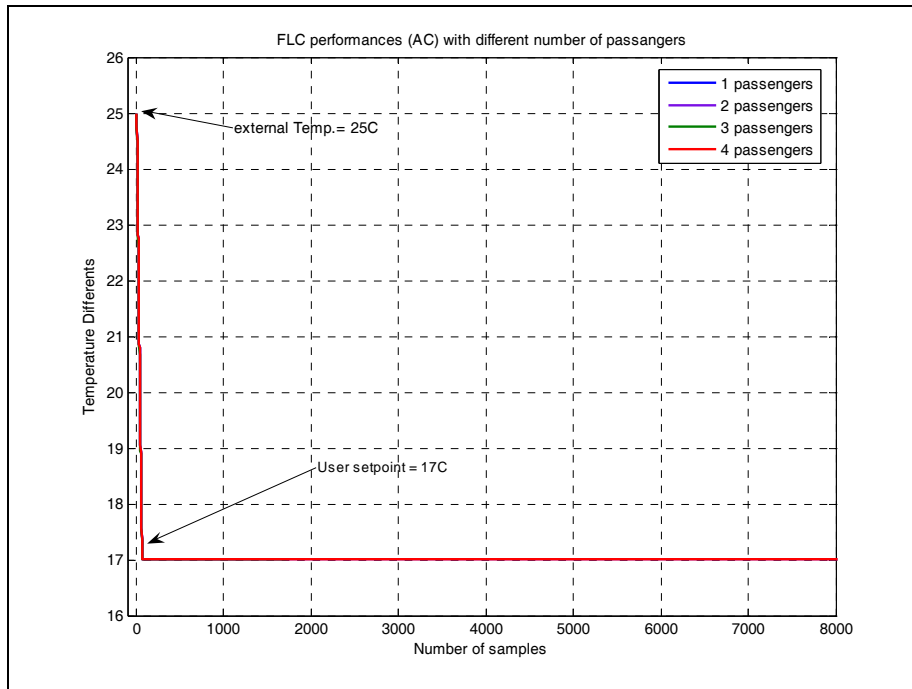

(a)

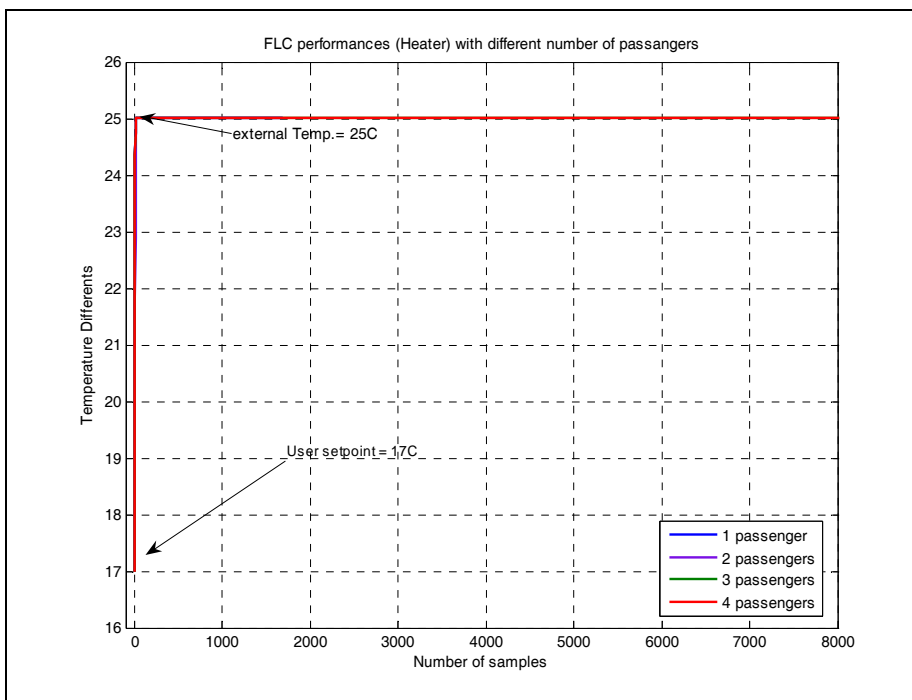

(b)

Figure 13. (a) FLC performance (AC) with different number of passengers (b) FLC performance (HEATER) with different number of passengers

the dead band of 0.5°C from desired temperature. Once the current temperature reaches 17.5°C , the air conditioning state will switch on and the current temperature will decrease immediately to 16.5°C . This will make the heater state switched on for a while and then both states will be switched off again when the difference value is less than 0.5°C or more then -0.5°C . This action will respond continuously until the desired temperature is reached.

Compared to fuzzy logic performance, air conditioning will be switched on until the desired temperature has been achieved and maintained until the user enters new values of set point. Rising time is faster. It is clearly shown in Figure 14 (a) and Figure 14 (b) that the capability of fuzzy logic controller to regulate the blower speed and state control at the desired temperature point is much better than the state flow controller.

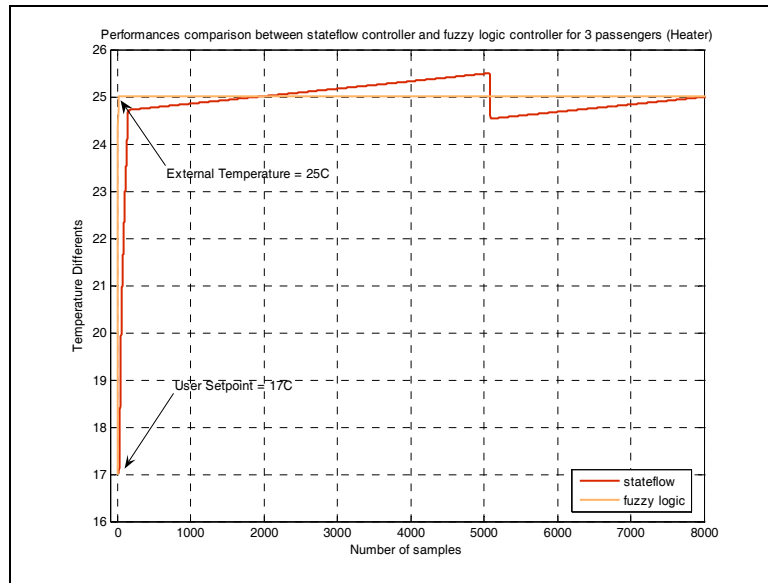

(a)

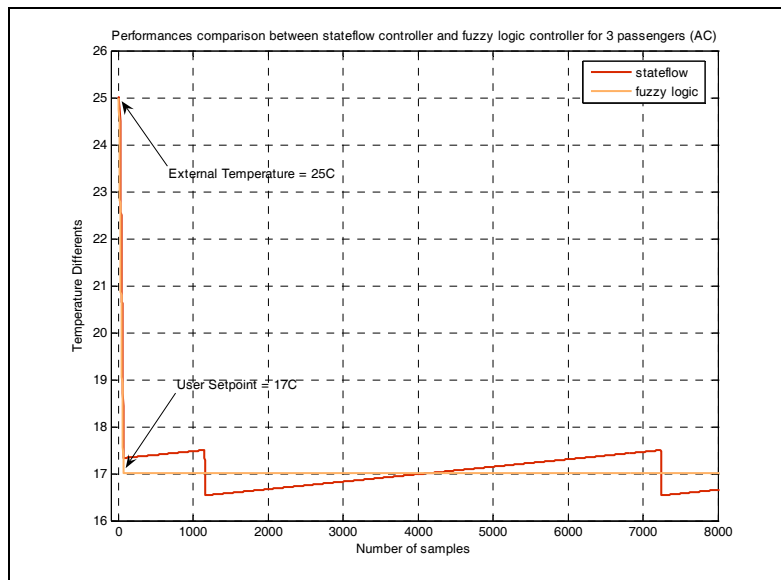

(b)

Figure 14. Performance comparison between state flow and fuzzy logic controller for three passengers (a) HEATER (b) AC

5. CONCLUSION

Throughout the project, many simulations have been carried out to study the implementation of fuzzy logic control in automobile climate control system. The simulations also include the study on the previous controller, which is state flow controller. The performance of both types of control techniques is carefully studied.

For the first model, as shown in Figure 3, if the user enters a set point temperature, which is greater than the current car temperature, the heater system will be switched on and active until the current temperature in the car reaches within 0.5°C of the set point temperature.

Vice versa, if the set point is less than the current temperature, appropriate changes will be done by the controller.

For the second model, as shown in Figure 4, there are two fuzzy logic controllers used in this model. FLCBLOWER is used to control blower speed proportion. The larger the range of temperature difference, the increase of the blower speed proportion is larger. But, the blower speed proportion values are also influenced by the number of passengers. This means that, although the range of temperature difference is the same, the output will change if the number of passengers in the car is different. The blower speed proportion will increase when the number of passengers increases. FLCSWITCH

is used to switch to either *AC State* or *Heater State* depending on the temperature difference values; being either negative or positive. If the difference is negative, it means that the set point temperature is less than the current temperature. Therefore, the air conditioning state will be switched on. If the difference is positive, it means that the set point temperature is larger than the current temperature and the heater state will be switched on. When the difference is zero, both of the states will be switched off by the fuzzy logic controller and the desired state will be maintained until the user changes the values.

Based on this research, the temperature control system for air conditioning and heater for the automobile climate control system can be optimized by using fuzzy logic as a controller. The ripple in the simulation result could be reduced and the time required to achieve the desired temperature could be decreased. By studying both controllers; state flow and fuzzy logic, we can really understand the characteristics of each type of controller. The knowledge gained from the analysis of each controller, leads us to obtain the best parameter for the controller.

Therefore, fuzzy logic control shows encouraging results in this simulation studies. This control technique is able to regulate blower speed proportion, air conditioning control, and heater control without the need of a mathematical model of the system and yet capable to provide non-linear relationship functions, rules, and defuzzification.

REFERENCES

- [1] B.H. Dwiggins, and E.F. Mahoney, *Automotive Electricity and Electronics: concepts and applications*. Prentice Hall, 1993, pp. 229-239.
- [2] C.L. Hock, "Simulation of Fuzzy Logic Control Implementation in Chemical Neutralisation Plant Using MATLAB's Simulink," Thesis, Universiti Teknologi Malaysia, 2002.
- [3] L. Reznik, *Fuzzy Controllers*. Oxford: Newnest, 1997, pp. 60-108.
- [4] B. Kosko, *Fuzzy Engineering*. Prentice Hall, 1997.
- [5] V.A. Constantin, *Fuzzy Logic and Neurofuzzy Applications Explained*. 1976, pp. 203-206.
- [6] W. Leonard, *Introduction to control Engineering and Linear Control System*. Springer-Verlag: Heidelberg, 1976, pp. 156-178.
- [7] H. Duane and L. Bruce, *Mastering MATLAB 6*. Pearson Education International, 2001, pp. 450-462.