

The Effect of Condensate Water on the Performance of Automotive Air Conditioning System under Difference Evaporator Air Inlet Temperature

Mohamad Firdaus Sukri^{1,2*}, Rusmiati Lokman², Asjufri Muhajir², Faizil Wasbari^{1,2}, Amir Abdullah Muhamad Damanhuri¹ and Kasni Sumeru³

¹Green and Efficient Energy Technology (GrEET) Research Group, Universiti Teknikal Malaysia Melaka, Hang Tuah Jaya, 76100 Durian Tunggal, Melaka, Malaysia.

²Fakulti Kejuruteraan Mekanikal, Universiti Teknikal Malaysia Melaka, Hang Tuah Jaya, Durian Tunggal, 76100, Melaka, Malaysia.

³Department of Refrigeration & Air Conditioning, Politeknik Negeri Bandung Gegerkalong Hilir Ciwaruga, Bandung 40012. Indonesia.

ABSTRACT

This paper experimentally investigates the effect of condensate water on the performance of automotive air conditioning (AAC) system under difference evaporator air inlet temperature. An experimental test rig was fabricated using the actual component of AAC system used for Proton Wira passenger car. During experimental work, the volume flow rate of condensate water was manipulated at 0, 140 and 340 ml/min. The evaporator air inlet temperature was also varied at 28, 32 and 36°C. The other parameters of compressor speed, condensate water temperature and condenser air inlet temperature were kept constant at 1550 rpm, $29 \pm 1^\circ\text{C}$ and $32 \pm 1^\circ\text{C}$, respectively. The study showed that the coefficient of performance (COP) of the AAC system increases when the volume flow rate of condensate water increased from 0 to 140 ml/min. It was due to a dominant decrease in compressor work, as compared to the drop in cooling capacity. In addition, the highest increment in COP occurred at evaporator air inlet temperature of 36°C (9.8%), followed by evaporator air inlet temperature of 28°C (2.8%) and 32°C (0.4%). The highest COP is 3.66, occurred at evaporator air inlet temperature of 32°C and volume flow rate of condensate water of around 140 ml/min.

Keywords: Vapour Compression Refrigeration Cycle, Air Conditioning System, Condensate Water, Sub-Cooling Method, COP Improvement.

1. INTRODUCTION

In hot and humid countries such as Malaysia and Indonesia, an automotive air conditioning (AAC) system is important to provide comfort to both driver and passengers. Sukri highlighted that comfort is not the only reason for the use of AAC systems as road safety also improves with the comfort of the driver and a pleasant environment reduces driver fatigue [1]. Typically, the AAC system is constructed based on vapour compression refrigeration cycle (VCRC) due to proven and matured technologies, plus ability to operate with longer operating hours as compared to other technologies such as ice storage technology, etc. However, there are two major drawbacks of this VCRC system. The first drawback is the needs to find the most ideal refrigerant that is excellent in performance, and at the same time friendly to the environment. Nowadays, one of the current refrigerant widely used in AAC system is HFC-134a. The refrigerant of HFC-134a has zero ozone-layer depletion potential but high global warming potential of around 1340 [2-3]. This value indicates that R134a has a global warming potential of 1340 times more than carbon dioxide (CO₂). As a result, the HFC-134a in the current AAC system will eventually be phased out because

*Corresponding Author: mohdfirdaus@utem.edu.my

of strong legislative pressure to protect the environment from global warming by reducing greenhouse gases. Due to this reason many research works had been carried out to identify ideal alternative refrigerants [4].

The second drawback is that this system consumes a relatively huge amount of energy. Johnson [5] showed that air conditioning (A/C) vehicles in the USA consume 27 billion litres of gasoline annually, which is equivalent to 6% of the domestic petroleum consumption or 10% of imported crude oil. Alahmer *et al.* [6] stated that the A/C system accounts for 30% of mile-per-gallon expenditure. As a result, there is a large number of research works that had been carried out and keep increasing in the various aspects with the aim to improve the efficiency of the AAC system. In general, researches to improve the efficiency of the AAC system can be divided into two categories; component optimization and efficient operational management and control method, as shown in Figure 1.

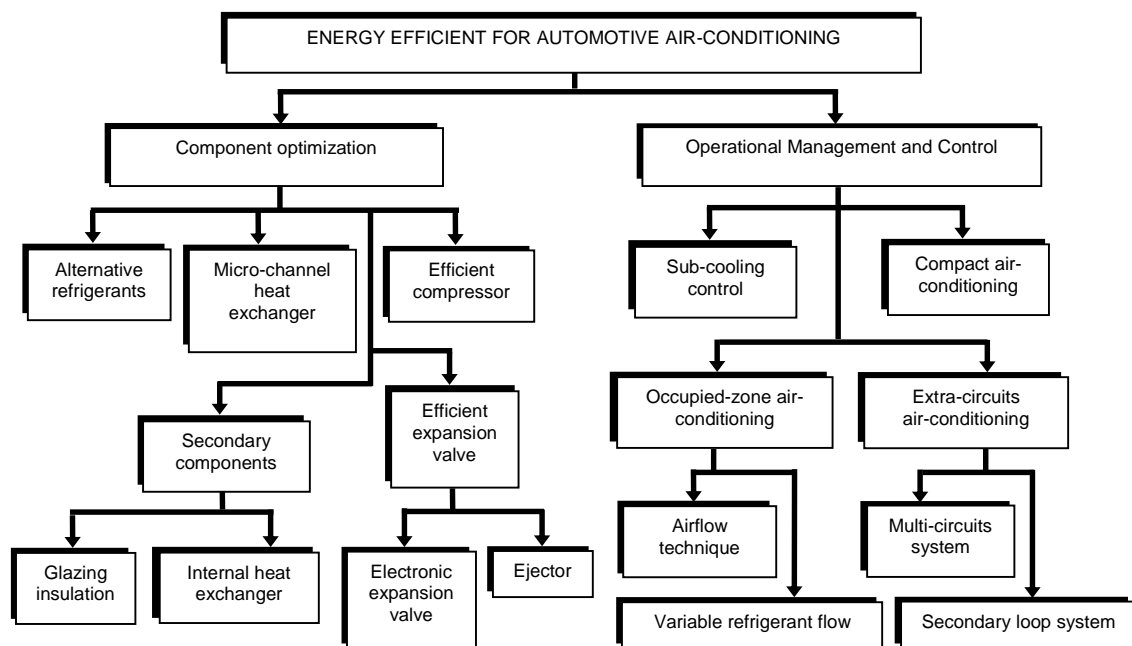

Figure 1. Method of energy-efficient for automotive air conditioning [1].

Recently, much attention had been given to the sub-cooling control method due to simple technology but proven in producing significant energy saving [7-8]. Sumeru *et al.* [9] classified 4 methods under the sub-cooling method, as in Figure 2.

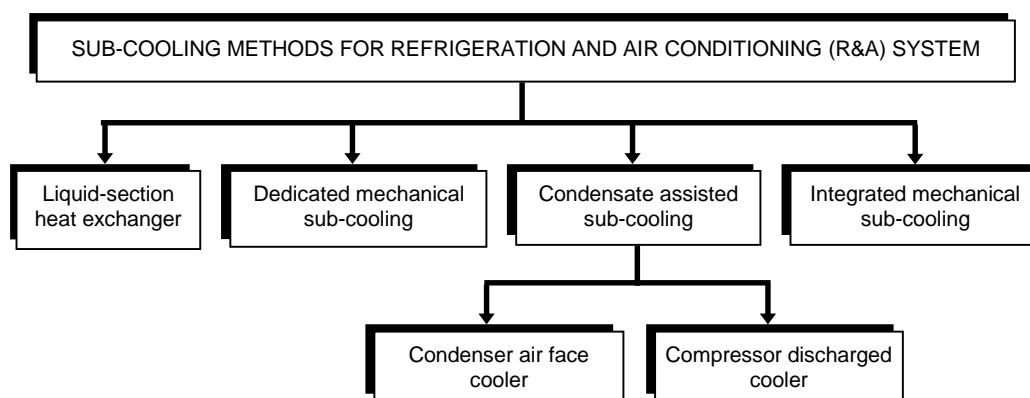

Figure 2. Methods of the sub-cooling technique [9].

There are a few numbers of studies that investigate the use of waste condensate water to improve the performance of air conditioning (AC) system [10-12]. Sawant *et al.* [10] utilized an evaporative cooling method using waste condensate water to decrease the air temperature that enters the condenser of a residential air conditioner. Their results showed a decrease in energy consumption of up to 10%. Sawant *et al.* [11] conducted an experimental study on the effect of evaporative cooling for condenser air inlet temperature of a split air conditioner in Beirut. They concluded that their method decreased energy consumption by 5% and 4.5% in June and August, respectively. Ibrahim *et al.* [12] also carried out an experimental investigation on the performance of the split unit air conditioner with a capacity of 1.5 tonnes refrigeration using condenser air face cooler. The result showed that the compressor power consumption was decreased by 6.1% while the refrigeration capacity and COP increased by 20.5% and 21.4% respectively.

In the method of condensate assisted sub-cooling, the low temperature of water vapour (slightly higher than 5°C [9, 13] that condensed in the evaporator surface is utilized to decrease the condenser air face temperature or compressor discharged cooler. The decrease in these temperatures helps the condenser in removing heat to the ambient air in a more efficient way. Consequently, the system generates better sub-cooling effects, which lead to an increase in cooling capacity and improved in performance of the system [10-11, 14].

Sumeru *et al.* [13] found that by utilizing a compressor discharged cooler method, a 5% reduction of compression ratio and 2.2K of sub-cooling were achieved. As a result, the compressor input power decreased by 6.3% due to decrement in discharge pressure and sub-cooling causes an increase in cooling capacity. However, an increase in cooling capacity was not quantified by the authors.

One of the other techniques that can be considered under the condensate assisted sub-cooling method is to cool the surface of the condenser using condensate water. So far, the effect of condensate water as condenser surface cooler is yet to be investigated at least to the authors' knowledge. Figure 3 shows a schematic diagram of the condenser air face/surface cooler method. Therefore, this paper intends to experimentally investigate the performance of the AAC system using waste condensate water as a condenser surface cooler.

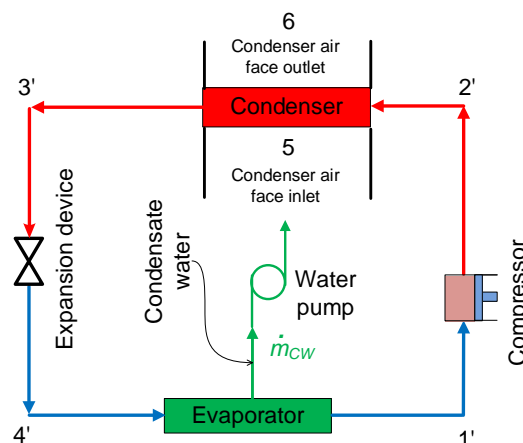

Figure 3 Method of utilizing waste condensate water as condenser surface cooler.

2. MATERIAL AND METHODS

An experimental test rig was fabricated from the original AAC system used in Proton Wira passenger car with R-134a as a working refrigerant. Figure 4 shows the actual AAC experimental

test rig. The schematic of the experimental test rig is shown in Figure 5. Specifications of all instrumentations used in the experimental test facility are shown in Table 1.

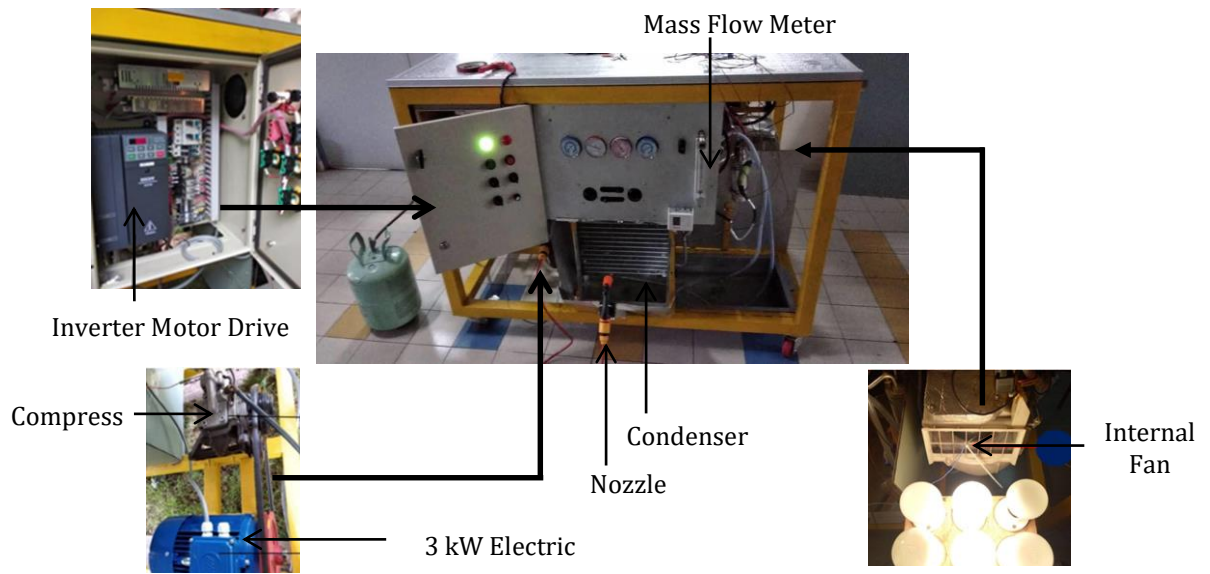

Figure 4. Actual AAC experimental test facility.

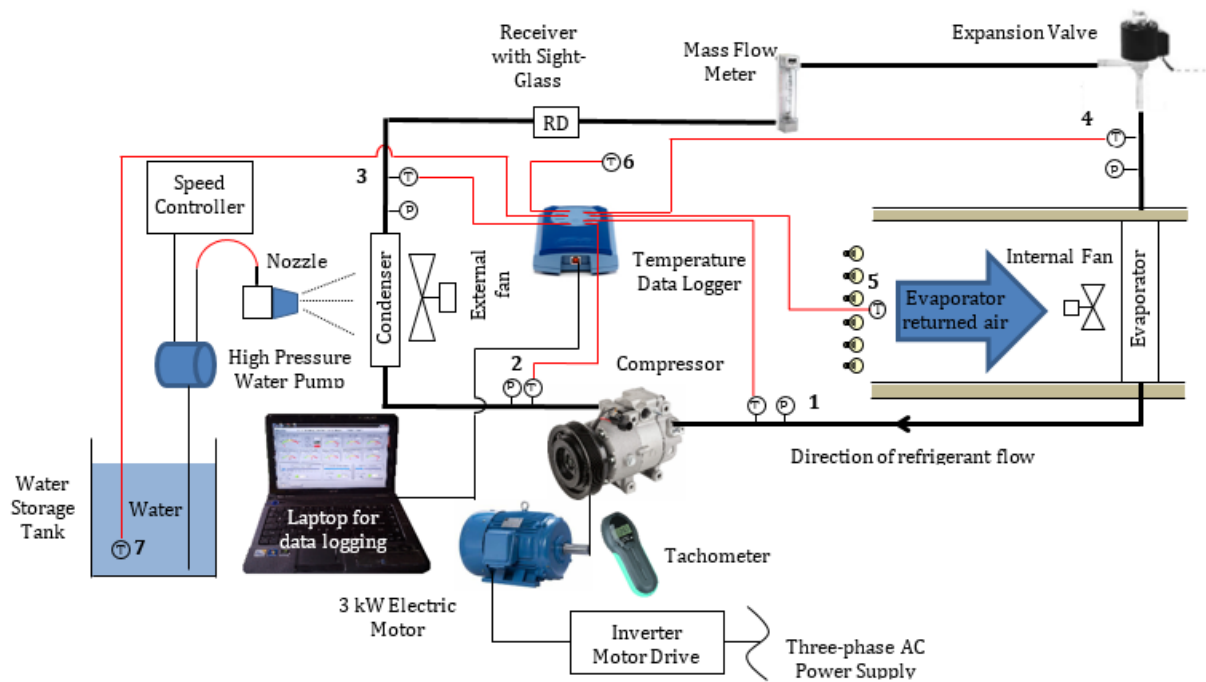

Figure 5. Schematic of AAC experimental test rig.

Table 1 Specification of experimental instrumentations

Instrumentation	Manufacturer/Model	Measuring Range	Systematic Uncertainty
Thermocouple	T-Type with TC-08 USB Pico Data Logger	-200:350°C	±0.75%
Pressure gauge	-	-100:3800/5300 kPa	-
Mass flow meter	Platton/NGX	4:56 g/s	±1.25% FSD
Digital Tachometer	Ono Sokki/HT-4100	30:24999 rpm	±1 rpm

The compressor was driven by a 3 kW electric motor controlled by a frequency inverter. The evaporator air return temperature was controlled manually by 6 bulbs with individual ON/OFF switch of each bulb. Each bulb consumes 100 W of electrical power. The condensate water was pumped and sprayed to the surface of the condenser using a high-pressure electric pump and a nozzle. The volume flow rate was controlled by a knob located at the control panel. Figure 4 shows an experimental test rig utilized in this study.

Four pressure gauges and a TC-08 USB temperature data logger with T-type thermocouple were used to measure refrigerant pressure and temperature at the inlet and outlet of each main component, respectively. A refrigerant mass flow meter was installed between the condenser and expansion valve. In addition, condenser air inlet temperature, condensate water temperature and evaporator air return temperature were also measured and controlled using a TC-08 USB temperature data logger with T-type thermocouple.

The experimental work was conducted in accordance with the *Procedure for Measuring System COP [Coefficient of Performance] of a Mobile Air Conditioning System on a Test Bench* [15]. It was conducted between 2.30 pm to 6.00 pm, so that constant condenser air inlet temperature of 32±1°C is achievable. In addition, compressor speed and temperature of condensate water were fixed at 1550 rpm and 29±1°C, respectively. The condensate air volume flow rate was set at 0, 140 and 340 ml/min, and the evaporator air return temperature were set at 28, 32 and 37°C. The test rig was run for 20 minutes to stabilize prior another 10 minutes for data collection with 20 seconds time interval. The average readings were considered as final reading for analysis.

The compressor work, W_c , cooling capacity, Q_e and COP were calculated from the refrigerant side using Eqs. (1) to (3),

$$W_c = m(h_2 - h_1) \quad (1)$$

$$Q_e = m(h_1 - h_4) \quad (2)$$

$$COP = Q_e/W_c \quad (3)$$

where m and h are refrigerant mass flow rate and refrigerant enthalpy respectively.

Point 1, 2 and 4 are inlet/outlet of main components as in Figure 4. The refrigerant enthalpy was determined using Refprop Mini software [16]. Two assumptions were made as accordance with simple vapour compression refrigeration cycle, where:

- a. Isentropic expansion process occurred in the expansion valve (process from point 3 to point 4), and
- b. Refrigerant is at saturated vapour at the inlet of the compressor (point 1).

3. RESULTS AND DISCUSSION

3.1 Compressor Work

Figure 6 shows the effect of condensate water on compressor work at different evaporator air inlet temperature. In general, an evaporator air inlet temperature of 28°C required highest compressor work, followed by an evaporator air inlet temperature of 36°C and 32°C. At the constant evaporator air inlet temperature, when the volume flow rate of condensate water increased from 0 to 140 ml/min, the compressor work decreases. However, the compressor work increases when the volume flow rate of condensate water increased from 140 to 340 ml/min, except when the evaporator air inlet temperature is set at 32°C. However, the decrement in compressor work at evaporator air inlet temperature of 32°C and volume flow rate of condensate water increased from 140 to 340 ml/min is not significant of just around 1.3%. In addition, a big gap of compressor work at 140 ml/min for the case of 28 and 32°C is identified. Since all fixed and independence parameters and well-controlled and manipulated, the authors agreed that this phenomenon is due to the thermal and energy balance of the air conditioning system at that steady-state condition. In general, condensate water sprayed on the surface of the condenser could decrease the compressor work at lower/optimal volume flow rate of condensate water and certain evaporator air inlet temperature.

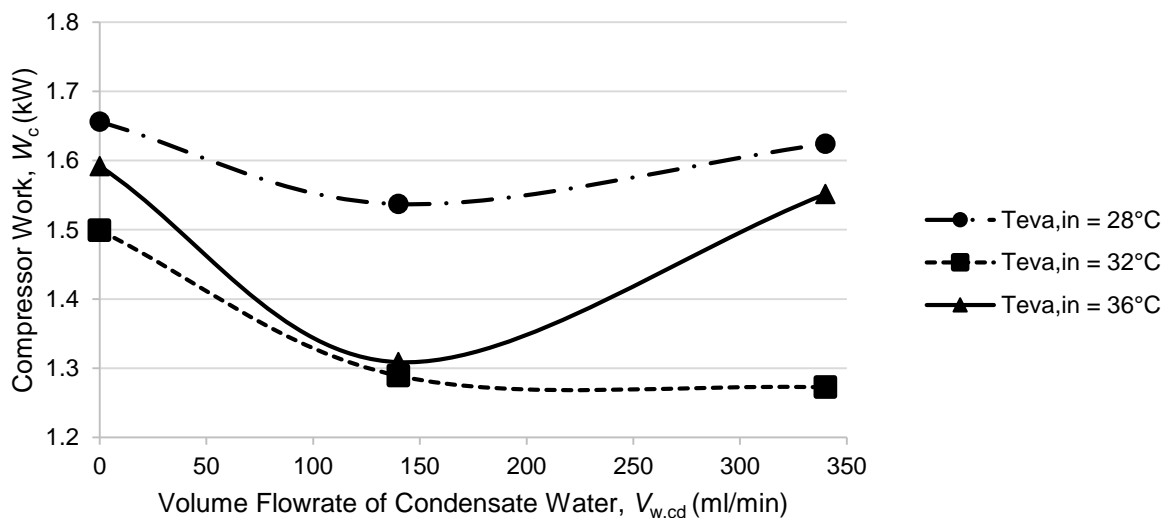

Figure 6. The effect of volume flow rate of condensate water on compressor work at difference evaporator air inlet temperature.

3.2 The Effect on Cooling Capacity

Figure 7 shows the effect of condensate water on cooling capacity at difference evaporator air inlet temperature. In general, the cooling capacity decreases as the volume flow rate of condensate water increased from 0 to 340 ml/min.

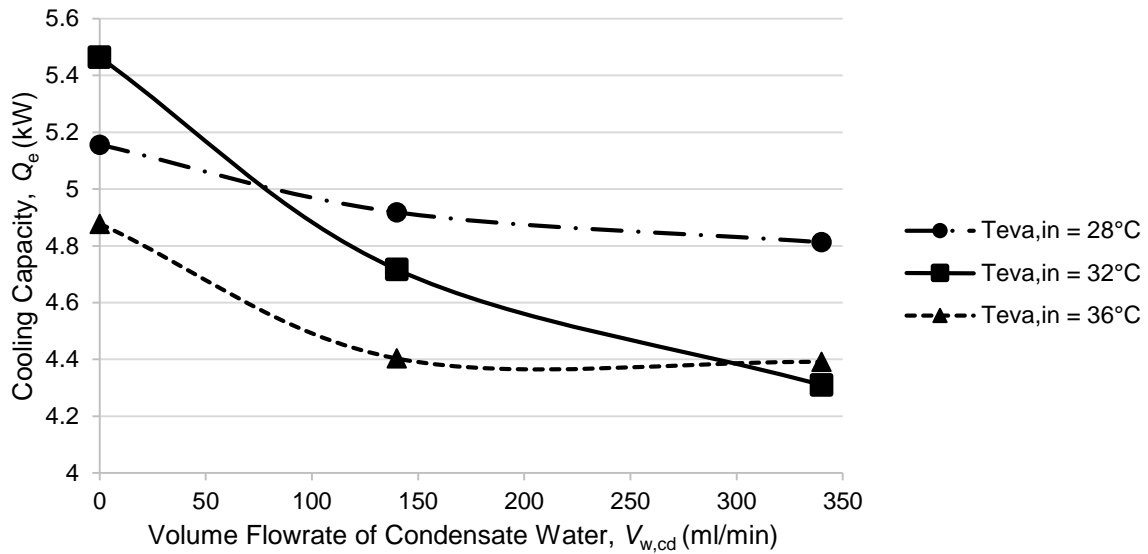

Figure 7. The effect of volume flow rate of condensate water on cooling capacity at difference evaporator air inlet temperature.

Figure 7 also shows that the rate of reduction in cooling capacity over volume flowrate of condensate water at evaporator air inlet temperature of 32°C is the greatest as compared to other evaporator air inlet temperature. In average, the highest reduction in cooling capacity occurred at evaporator inlet air temperature of 32°C (21.1%), followed when evaporator inlet air temperature of 36°C (10.0%) and 28°C (6.7%).

3.3 The Effect on COP

Figure 8 shows the effect of condensate water on COP of the AAC system at difference evaporator air inlet temperature. The best operating condition of this system appears when the evaporator air inlet temperature was set at 32°C at condensate water of 140 ml/min, with the highest COP of 3.66.

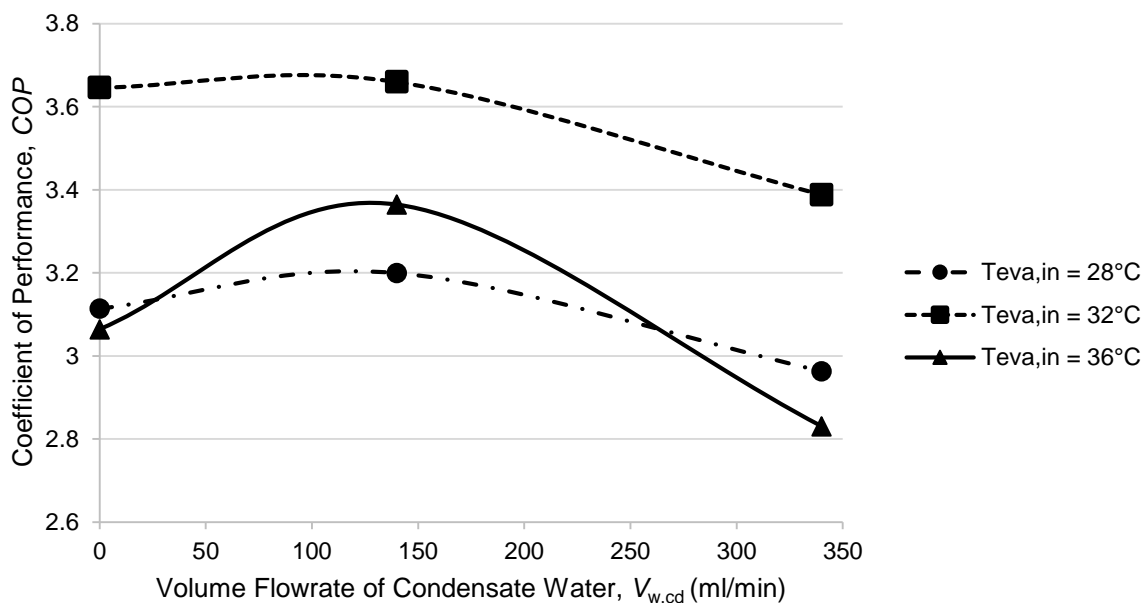

Figure 8. The effect of volume flow rate of condensate water on COP at difference evaporator air inlet temperature.

In general, due to the air conditioning system energy balance, the COP increases when condensate assisted sub-cooling was introduced at a lower flow rate of less than 140 ml/min. The highest increment of COP occurred at evaporator air inlet temperature of 36°C (9.8%), followed by evaporator air inlet temperature of 28°C (2.8%) and 32°C (0.4%). It shows that the decrease in compressor work is dominant as compared to the decrease in cooling capacity at condensate water of less than 140 ml/min. However, when the condensate water increased from 140 to 340 ml/min, a continuous decrement in cooling capacity with an increase or low decrement in compressor work led to a significant reduction in COP. The highest drop in COP is 15.9% which occurred at evaporator air inlet temperature of 36°C.

4. CONCLUSION

The performance of the AAC system with waste condensate water as a condenser surface cooler at difference evaporator air inlet temperature was investigated. In general, due to system energy balance, the COP of the AAC system increases at a lower volume flow rate of less than 140 ml/min. It was due to a dominant reduction in compressor work as compared to decreasing cooling capacity. The highest increment of COP occurred at evaporator air inlet temperature of 36°C (9.8%), followed by evaporator air inlet temperature of 28°C (2.8%) and 32°C (0.4%).

However, at a higher volume flow rate of more than 140 ml/min, the COP decreases with the highest drop of 15.9% occurred at the evaporator air inlet temperature of 36°C. It was due to continuous decrement in cooling capacity but an increase in compressor work. The highest COP is 3.66, occurred at evaporator air inlet temperature of 32°C and condensate water of 140 ml/min.

ACKNOWLEDGEMENT

This study was funded by Universiti Teknikal Malaysia Melaka (UTeM), under Short Term Grant with project no. PJP/2018/FKM(1A)/S01591. The authors were also grateful to Fakulti Kejuruteraan Mekanikal, Universiti Teknikal Malaysia Melaka for the facilities and management supports.

REFERENCES

- [1] Sukri, M. F., Musa M. N., Senawi, M. Y. & Nasution, H. Achieving a better energy-efficient automotive air-conditioning system: A review of potential technologies and strategies for vapor compression refrigeration cycle. *Energy Efficiency*, 6 (2015) 1201–1229.
- [2] Li, G., Eisele, M., Lee, H., Hwang, Y., & Radermacher, R. Experimental investigation of energy and exergy performance of secondary loop automotive air-conditioning systems using low-GWP (global warming potential) refrigerants. *Energy*, 68 (2014) 819–831.
- [3] Wu, M., Yuan, X. R., Xu, Y. J., Qiao, X. G., Han, X. H., & Chen, G.M. Cycle performance study of ethyl fluoride in the refrigerant system of HFC-134a. *Applied Energy*, issue 136, (2014) pp. 1004–1009.
- [4] Tritjahjono, R. I., Sumeru, K., Setyawan, A. & Sukri, M.F. Evaluation of Subcooling with Liquid-Suction Heat Exchanger on the Performance of Air Conditioning System Using R22/R410A/R290/R32 as Refrigerants. *Journal of Advanced Research in Fluid Mechanics and Thermal Sciences*, 1 (2019) 1-11.

- [5] Johnson, V. H. Fuel used for vehicle air-conditioning: A state-by-state thermal comfort-based approach. SAE Technical Paper, (2002) 2002-01-1957.
- [6] Alahmer, A., Abdelhamid, M. & Omar, M. Design of thermal sensation and comfort states in vehicles cabins. Applied Thermal Engineering, 36 (2012) 126-140.
- [7] Pitarch, M., Hervás-Blasco, E., Navarro-Peris, E., González-Marcía, J. and Corberán, J. M. Evaluation of optimal subcooling in subcritical heat pump systems. International Journal of Refrigeration, 78 (2017) 18-31.
- [8] Llopis, R., Nebot-André, L., Sánchez, D., Catalán-Gil, J. & Cabello, R. Subcooling methods for CO₂ refrigeration cycles: A review. International Journal of Refrigeration, 93 (2018) 85-107.
- [9] Sumeru, K., Sukri, M. F., Falahuddin, M. A. and Setyawan, A. A review on sub-cooling in vapor compression refrigeration cycle for energy saving. Jurnal Teknologi, 5 (2019) 155-170.
- [10] Sawant, A. P., Agrawal, N. & Nanda, P. Performance assessment of an evaporative cooling-assisted window air conditioner. International Journal of Low-Carbon Technology, 7 (2011) 128-136.
- [11] Sawant, R., Ghali, K. & Al-Hindi, M. Use of condensate drain to pre-cool the inlet air to the condensers: a technique to improve the performance of split air conditioning units. HVAC&R Research, 18 (2012) 37-41.
- [12] Ibrahim, N. I., Al-Farayedhi, A. A. & Gandhidasan, P. Experimental investigation of a vapor compression system with condenser air pre-cooling by condensate. Applied Thermal Engineering, 110 (2017) 1255-1263.
- [13] Sumeru, K. Cecep Sunardi, & Sukri, M.F. Effect of compressor discharge cooling using condensate on performance of residential air conditioning system. In Proceedings of the 9th International Conference on Thermofluids 2017 (Thermofluid 2017), 020002-1-020002-6 (2017).
- [14] Tissot, J., Boulet, P., Trinquet, F., Fournaison, L., Lejeune, M. & Liaudet, F. Improved Energy performance of a refrigerating machine using water spray upstream of the condenser. International Journal of Refrigeration **38**, 1 (2013) 93-105.
- [15] Society of Automotive Engineers. J2765. United States of America: Society of Automotive Engineers, (2008).
- [16] Lemmon, E. W., Huber, M. L. & McLinden, M. O. NIST Standard Reference Database 23: Reference Fluid Thermodynamic and Transport Properties-REFPROP, Version 9.1. Gaithersburg: National Institute of Standards and Technology, Standard Reference Data Program, (2013).

